

# Proper Orthogonal Decomposition Mathematics & practical aspects

Michael Hinze

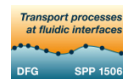

Durham, August 8-10, 2017

# Outline

## Lecture 1: The POD technique

- Motivation

- POD principle

- An example: POD in flow control

- POD error analysis

- Treatment of the nonlinearity  $\rightarrow$  DEIM/QDEIM

- Marry POD with adaptivity

## Lecture 2: Optimization with POD surrogate models

- Optimization with the reduced model - the beginnings

- Motivation: optimization problem with pde constraints

- Mathematical setting, state equation

- Optimization problem with POD surrogate model

- Numerical analysis of POD in PDE constrained optimization

- POD-MOR and adaptive concepts

- Further aspects & alternatives

## Lecture 3: Towards (parametrized) POD-MOR of PDE systems in networks

## Collaboration

- **Konstantin Afanasiev,**
- **Oke Aiff,**
- **Allesandro Alla,**
- **Carmen Gräßle,**
- **Christian Kahle,**
- **Martin Kunkel,**
- **Ulrich Matthes,**
- **Morten Vierling,**
- **Stefan Volkwein.**

## Motivation

**We have a validated mathematical model for physical process (here a pde system)**

**We intend to use this model to **tailor and/or optimize** the physical process.**

**This might be computationally very expensive!**

## Motivation: $\infty$ -dimensional optimization problem with pde constraints

$$\begin{aligned} \min_{(y,u) \in W \times U_{ad}} \quad & J(y, u) \\ \text{s.t.} \quad & \\ \frac{\partial y}{\partial t} + \mathcal{A}y + \mathcal{G}(y) &= \mathcal{B}u \text{ in } Z^* \\ y(0) &= y_0 \text{ in } H. \end{aligned}$$

### Central tasks:

- Develop solution strategies which obey the rule

$$\text{Effort of optimization} = K \times \text{Effort of simulation}$$

with  $K$  small,

- Propose surrogate models for the pde and quantify their errors,
- Present a complete (numerical) analysis.

## Examples of pde systems

Find  $y \in W(0, T) = \{v \in L^2(0, T; V), y_t \in L^2(0, T; V^*)\}$  which solves

$$\begin{aligned} \frac{\partial y}{\partial t} + \mathcal{A}y + \mathcal{G}(y) &= \mathcal{B}u \text{ in } Z(= L^2(0, T; V)) \\ y(0) &= y_0 \text{ in } H. \end{aligned}$$

- 1 Heat equation:  $\mathcal{A} := -\Delta$ .
- 2 Burgers:  $\mathcal{A} := -\Delta$ ,  $\mathcal{G}(y) := yy'$ ,
- 3 Ignition (Bratu):  $\mathcal{A} := -\Delta$ ,  $\mathcal{G}(y) := -\delta e^y$ ,  $\delta > 0$ ,
- 4 Navier–Stokes:  $\mathcal{A} := -P\Delta$ ,  $\mathcal{G}(y) := P[(y \nabla)y]$ ,  $P$  Leray projector,
- 5 Boussinesq Approximation:  

$$\mathcal{A} := \begin{bmatrix} -P\Delta & -G\vec{g} \\ 0 & -\Delta \end{bmatrix}, \mathcal{G}(y) = \mathcal{G}(v, \theta) := \begin{bmatrix} P[(v \nabla)v] \\ (v \nabla)\theta \end{bmatrix}.$$
- 6 Cahn–Hilliard and Cahn–Hilliard/Navier–Stokes systems.

## DOF diagram

**Spatial  
Discretization**

**DOF for full  
optimization**

○ **DOF for Moving  
Horizon Approach**



**DOF for Moving Horizon combined  
with Model Reduction**



**DOF for Model  
Reduction Approach**



## Motivation: parametrized PDEs

Consider for  $\mu = (\mu_1, \mu_2) > 0$

$$-\operatorname{div} (A(x; \mu) \nabla y) = f \text{ in } \Omega, \quad y = 0 \text{ on } \partial\Omega,$$

with

$$A(x; \mu) = \begin{cases} \mu_1, & x \in R, \\ \mu_2, & x \in \Omega \setminus R. \end{cases}$$

**Aim: find a surrogate model**

$$-\operatorname{div} (\tilde{A} \nabla y) = f \text{ in } \Omega, \quad y = 0 \text{ on } \partial\Omega,$$

**which represents the parameter dependent problem sufficiently well over the parameter domain.**

→ question will be touched in lecture III.



## The POD principle

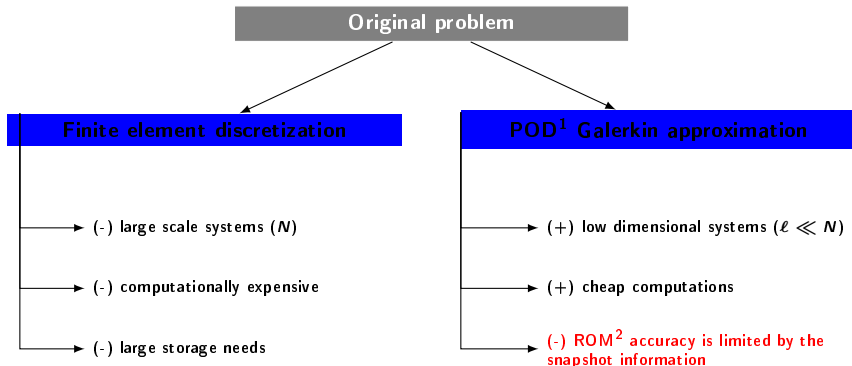

<sup>1</sup>Proper Orthogonal Decomposition [L. Sirovich '87]

<sup>2</sup>Reduced Order Model

## The POD principle

Dynamical system

$$\begin{aligned}\dot{y}(t) &= f(t, y(t)), & t \in (0, T) \\ y(0) &= y_0\end{aligned}$$

## The POD principle

Dynamical system

$$\begin{aligned}\dot{y}(t) &= f(t, y(t)), \quad t \in (0, T) \\ y(0) &= y_0\end{aligned}$$

POD Galerkin ansatz

$$y(t) \approx y^\ell(t) = \sum_{i=1}^{\ell} \eta_i(t) \psi_i$$

→ compute modes  $\{\psi_i\}_{i=1}^{\ell}$  from system information

# The POD principle

Dynamical system

$$\begin{aligned} \dot{y}(t) &= f(t, y(t)), \quad t \in (0, T) \\ y(0) &= y_0 \end{aligned}$$

POD Galerkin ansatz

$$y(t) \approx y^\ell(t) = \sum_{i=1}^{\ell} \eta_i(t) \psi_i$$

→ compute modes  $\{\psi_i\}_{i=1}^{\ell}$  from system information

1) Let's take snapshots:

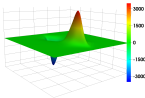

$y^1$



# The POD principle

Dynamical system

$$\begin{aligned} \dot{y}(t) &= f(t, y(t)), \quad t \in (0, T) \\ y(0) &= y_0 \end{aligned}$$

POD Galerkin ansatz

$$y(t) \approx y^\ell(t) = \sum_{i=1}^{\ell} \eta_i(t) \psi_i$$

→ compute modes  $\{\psi_i\}_{i=1}^{\ell}$  from system information

1) Let's take snapshots:

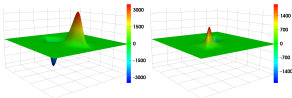

# The POD principle

Dynamical system

$$\begin{aligned} \dot{y}(t) &= f(t, y(t)), \quad t \in (0, T) \\ y(0) &= y_0 \end{aligned}$$

POD Galerkin ansatz

$$y(t) \approx y^\ell(t) = \sum_{i=1}^{\ell} \eta_i(t) \psi_i$$

→ compute modes  $\{\psi_i\}_{i=1}^{\ell}$  from system information

1) Let's take snapshots:

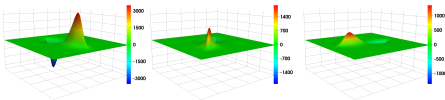

$y^1 \quad y^2 \quad y^3 \quad \dots$



## The POD principle

### 2) Compute SVD (singular value decomposition):

$$Y = [y^1 \ y^2 \ y^3] = \Psi \Sigma \Phi^T$$

$N \times n$                        $N \times N$        $N \times n$        $n \times n$

3) Truncate:  $\Psi^\ell = [\psi_1, \dots, \psi_\ell], \ell \ll N$

4) Set up ROM:  $y(t) \approx y^\ell(t) = \Psi^\ell \eta(t)$

Full order system

$$\begin{aligned}
 \dot{y}(t) &= f(t, y(t)), \quad t \in (0, T) \\
 y(0) &= y_0
 \end{aligned}$$

$\Rightarrow$

Reduced order model

$$\begin{aligned}
 \dot{\eta}(t) &= f(t, \eta(t)), \quad t \in (0, T) \\
 \eta(0) &= \eta_0
 \end{aligned}$$

# The POD principle

## 2) Compute SVD (singular value decomposition):

$$Y = [y^1 \ y^2 \ y^3] = \Psi \Sigma \Phi^T$$

$N \times n$                        $N \times N$        $N \times n$        $n \times n$

## 3) Truncate: $\Psi^\ell = [\psi_1, \dots, \psi_\ell], \ell \ll N$

## 4) Set up ROM: $y(t) \approx y^\ell(t) = \Psi^\ell \eta(t)$

Full order system

$$\begin{aligned}
 \dot{y}(t) &= f(t, y(t)), \quad t \in (0, T) \\
 y(0) &= y_0
 \end{aligned}$$

$\Rightarrow$

Reduced order model

$$\begin{aligned}
 \dot{\eta}(t) &= f(t, \eta(t)), \quad t \in (0, T) \\
 \eta(0) &= \eta_0
 \end{aligned}$$



## The POD principle

2) Compute SVD (singular value decomposition):

$$Y = [y^1 \ y^2 \ y^3] = \Psi \Sigma \Phi^T$$

$N \times n$                        $N \times N$        $N \times n$        $n \times n$

3) Truncate:  $\Psi^\ell = [\psi_1, \dots, \psi_\ell], \ell \ll N$

4) Set up ROM:  $y(t) \approx y^\ell(t) = \Psi^\ell \eta(t)$

Full order system

$$\begin{aligned}
 \dot{y}(t) &= f(t, y(t)), \quad t \in (0, T) \\
 y(0) &= y_0
 \end{aligned}$$

$\Rightarrow$

Reduced order model

$$\begin{aligned}
 \dot{\eta}(t) &= f(t, \eta(t)), \quad t \in (0, T) \\
 \eta(0) &= \eta_0
 \end{aligned}$$

# The beginning of snapshot POD with Sirovich '87: POD in flow control

## Navier-Stokes equations

$$\begin{aligned}
 \frac{\partial \mathbf{y}}{\partial t} + (\mathbf{y} \cdot \nabla) \mathbf{y} - \nu \Delta \mathbf{y} + \nabla p &= \mathbf{f} && \text{in } Q = (0, T) \times \Omega, \\
 -\operatorname{div} \mathbf{y} &= 0 && \text{in } Q, \\
 \mathbf{y}(t, \cdot) &= \mathbf{g} && \text{on } \Sigma = (0, T) \times \partial\Omega, \\
 \mathbf{y}(0, \cdot) &= \mathbf{y}_0 && \text{in } \Omega.
 \end{aligned}$$

**Aim: Reduced description of the Navier-Stokes equations**

$$\begin{aligned}
 \dot{\alpha} + A\alpha + n(\alpha) &= r && \text{in } (0, T) \\
 \alpha(0) &= a_0
 \end{aligned}$$

## 1. Construction and validation of the reduced model

## System reduction: Expansions w.r.t. base flows

Let  $\bar{y}$  denote a base flow and  $\Phi^i$ ,  $i = 1, \dots, n$  Modes.  
Ansatz for the flow:

$$y = \bar{y} + \sum_{i=1}^n \alpha_i \Phi^i$$

Possibilities:

- $\bar{y}$  stationary solution of Navier-Stokes system,  $\Phi^i$  eigenfunctions of the Navier-Stokes system linearized at  $\bar{y}$ .
- $\bar{y}$  mean value of instationary Navier-Stokes solution,  $\Phi^i$  eigenfunctions of the Navier-Stokes system linearized at  $\bar{y}$ .
- $\bar{y}$  mean value of instationary Navier-Stokes solution,  $\Phi^i$  normalized Modes obtained from snapshot form of **P**roper **O**rthogonal **D**ecomposition.

## Snapshot form of POD

Let's take snapshots:

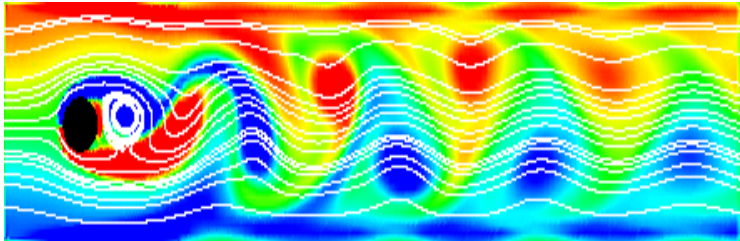

## POD with Snapshots

Let  $y^1, \dots, y^n$  denote an ensemble of snapshots (of the flow or the dynamical system). Build mean  $\bar{y}$  and modes  $\Phi_i$  as follows:

- 1 Compute mean  $\bar{y} = \frac{1}{n} \sum_{i=1}^n y^i$
- 2 Build correlation matrix  $K = k_{ij}$ ,  $k_{ij} = \langle y^i - \bar{y}, y^j - \bar{y} \rangle$
- 3 Compute eigenvalues  $\lambda_1, \dots, \lambda_n$  and eigenvectors  $v^1, \dots, v^n$  of  $K$
- 4 Define modes  $\Phi^i := \sum_{j=1}^n v_j^i (y^j - \bar{y})$
- 5 Normalize modes  $\Phi^i = \frac{\Phi^i}{\|\Phi^i\|}$

Properties:

- The modes are pairwise orthogonal w.r.t. inner product  $\langle \bullet, \bullet \rangle$
- No other basis can contain more information in fewer elements (Information w.r.t. the norm induced by  $\langle \bullet, \bullet \rangle$ ).

# First 10 Modes containing 99.99 % of the information

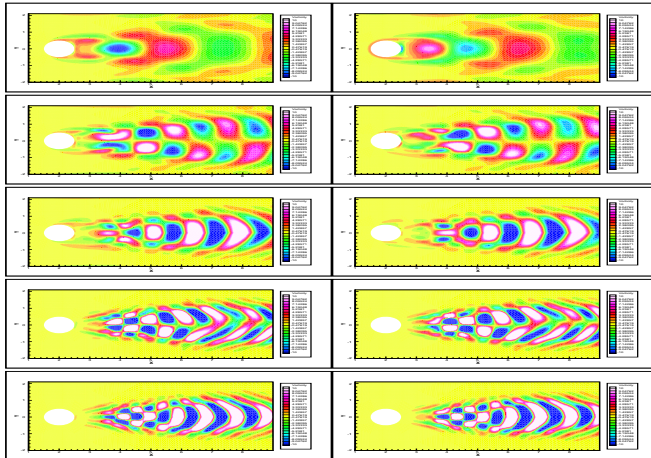

## Galerkin projection

**Ansatz for the flow**

$$y = \bar{y} + \sum_{i=1}^n \alpha_i \Phi^i$$

**Galerkin method with basis  $\Phi_1, \dots, \Phi_n$  yields reduced system**

$$\dot{\alpha} + A\alpha + n(\alpha) = r \quad \alpha(0) = a_0.$$

Here,  $\langle \bullet, \bullet \rangle$  denotes the  $L^2$  inner product.

$$A = (a_{i,j})_{i=1}^n, \quad a_{i,j} = \nu \int_{\Omega} \nabla \Phi_i \nabla \Phi_j \, dx, \quad n(\alpha) = \left( \int_{\Omega_c} (y \nabla y) \Phi_i \, dx \right)_{i=1}^n$$

$$r = -\nu \left( \int_{\Omega} \nabla \bar{y} \nabla \Phi_i + f \Phi_i \, dx \right)_{i=1}^n \quad \text{and} \quad a_0 = \left( \int_{\Omega} y_0 \Phi_i \, dx \right)_{i=1}^n.$$

**Note that  $\Phi_1, \dots, \Phi_n$  are solenoidal.**



## Long-time behaviour of the POD model

Amplitudes of the first mode in [34,44] when using  $N$  modes in the POD model

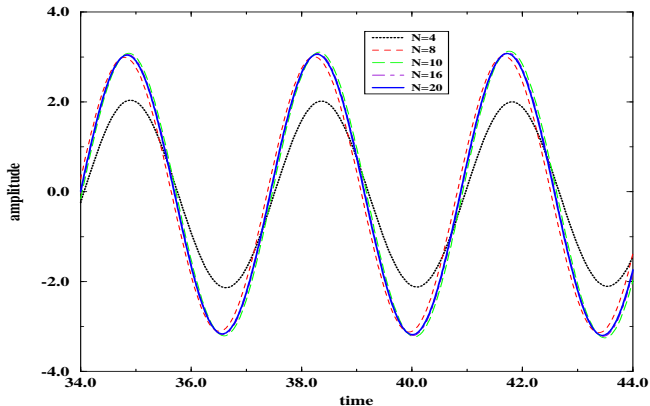

## Cylinder flow at $Re = 100$ , reduced versus full model, 50 snapshots

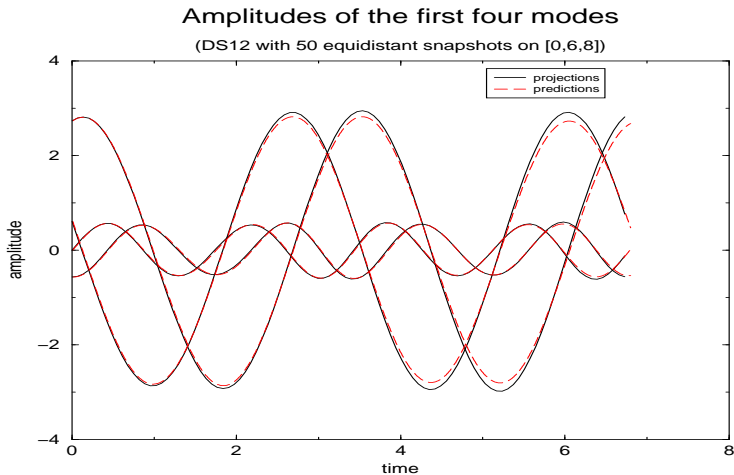

## What did Sirovich propose?

- Take snapshots  $y(t_1), \dots, y(t_n)$ ,

- perform a singular value decomposition with

$$Y := [y(t_1), \dots, y(t_n)] = \Phi \Sigma V^t,$$

where  $\Sigma = \text{diag}(\sqrt{\lambda_i})$ ,

- perform a Galerkin method with those modes  $\Phi_1, \dots, \Phi_l$  as basis elements which carry as much information as required (say 99%, say).

## Today's point of view

Find a basis  $\Phi_1, \dots, \Phi_l \in V$  such that

$$\{\Phi_1, \dots, \Phi_l\} = \arg \min \int_0^T \|y(t) - \sum_{i=1}^l \langle y(t), \Phi_i \rangle \Phi_i\|_V^2 dt.$$

On the discrete level we solve instead ( $y(t_j)$  are  $N$ -vectors, so are  $\Phi_j$ )

$$\begin{aligned} \min_{\Phi_1, \dots, \Phi_l} \sum_{j=0}^n \beta_j \left\| y(t_j) - \sum_{i=1}^l \langle y(t_j), \Phi_i \rangle \Phi_i \right\|^2 \\ \text{s.t. } \langle \Phi_j, \Phi_i \rangle = \delta_{ij} \quad \text{for } 1 \leq i, j \leq l, \end{aligned}$$

where  $\beta_j$  are nonnegative quadrature weights for  $\int_0^T \cdot dt$ .

The projection error then satisfies

$$\sum_{j=0}^n \beta_j \left\| y(t_j) - \sum_{i=1}^l \langle y(t_j), \Phi_i \rangle \Phi_i \right\|^2 = \sum_{i=l+1}^n \lambda_i.$$

## Some remarks

- **The choice of the snapshots is very important.**
- **Generation of snapshots with time-adaptivity.**
- **Snapshots should comply with physical properties of the underlying dynamical system, like periodicity of the flow, say.**
- **The Galerkin basis depends on the input (initial state  $y_0$ , rhs  $\mathcal{B}u$ ).**

## Error estimate (Kunisch and Volkwein (Numer. Math. 2001, SINUM 2002))

The error analysis for POD reduced systems is now along the lines of error analysis for Galerkin approximations of time dependent problems;

Let  $y(t_1), \dots, y(t_n)$  denote snapshots taken on an equidistant time grid of  $[0, T]$  with gridsize  $\delta t$ . Let  $\lambda_1 > \dots > \lambda_d > 0$  denote the strictly positive eigenvalues of the correlation matrix  $K$ . For  $l \leq d$  let  $V_l = \langle \Phi_1, \dots, \Phi_l \rangle$ . Further set

$$Y_k := \sum_{i=1}^l \alpha_i(t_k) \Phi_i.$$

Then

$$\delta t \sum_{i=1}^n |Y_i - y(t_i)|_H^2 \leq C \left\{ \sum_{i=l+1}^d |\langle y_0, \Phi_i \rangle_V|^2 + \frac{1}{\delta t^2} \sum_{i=l+1}^d \lambda_i + \delta t^2 \right\}.$$

- This result also extends to the case of distinguish time and snapshot grids.
- Improvements of reduced models and error estimate by different weighting of snapshots (include e.g. derivative information).
- Related more general analysis by Singler in SINUM 52, 2014, and Chapelle et. al in M2AN 2012.

## Wave equations (Herkt, H., Pinnau, ETNA 2013)

Consider the linear wave equation

$$\begin{aligned} \langle \ddot{x}(t), \phi \rangle_H + D \langle \dot{x}(t), \phi \rangle_H + a(x(t), \phi) &= \langle f(t), \phi \rangle_H \\ &\text{for all } \phi \in V \text{ and } t \in [0, T], \\ \langle x(0), \psi \rangle &= \langle x_0, \psi \rangle_H \text{ for all } \psi \in H, \\ \langle \dot{x}(0), \psi \rangle &= \langle \dot{x}_0, \psi \rangle_H \text{ for all } \psi \in H, \end{aligned}$$

Then POD based on the Newark scheme delivers an error estimate of the form

$$\begin{aligned} \Delta t \sum_{k=1}^m \left\| X^k - x(t_k) \right\|_H^2 &\leq \\ &\leq C_l \left( \left\| X^0 - P^l x(t_0) \right\|_H^2 + \left\| X^1 - P^l x(t_1) \right\|_H^2 + \Delta t \left\| \partial X^0 - P^l \dot{x}(t_0) \right\|_H^2 \right. \\ &\quad \left. + \Delta t \left\| \partial X^1 - P^l \dot{x}(t_1) \right\|_H^2 + \Delta t^4 + \left( \frac{1}{\Delta t^4} + \frac{1}{\Delta t} + 1 \right) \sum_{j=l+1}^d \lambda_{ij} \right) \end{aligned}$$

- In general only linear decay of modes.
- Critical dependence on  $\Delta t$  can be avoided by including derivative information into the snapshot set.

## Decay of singular values for POD with parabolic equations

Linear heat equation with  $y_0 \equiv 0$  and inhomogeneous boundary data.  
FE-solution  $\{y^h(t_j)\}_{j=0}^m$  computed on equi-distant time grid.

Snapshots:

$$y_j = \begin{cases} y^h(t_{j-1}) & \text{for } 1 \leq j \leq m+1, \\ \frac{y^h(t_{j-m-1}) - y^h(t_{j-m-2})}{\Delta t} & \text{for } m+2 \leq j \leq 2m+1. \end{cases}$$

Correlation matrix

$$(k_{ij})_{i,j=1}^{2m+1}, \quad k_{ij} = \langle y_i, y_j \rangle_V$$

Expected decay of its eigenvalues:

$$\lambda_i = \lambda_1 e^{-\alpha(i-1)} \quad \text{for } i \geq 1.$$

Experimental order of decay:

$$Q(\ell) = \ln \frac{\|y^\ell - y\|_{L^2(0,T;X)}^2}{\|y^{\ell+1} - y\|_{L^2(0,T;X)}^2} \Rightarrow EOD := \frac{1}{\ell_{\max}} \sum_{k=1}^{\ell_{\max}} Q(k) \approx \alpha.$$



## Decay of eigenvalues and of norms

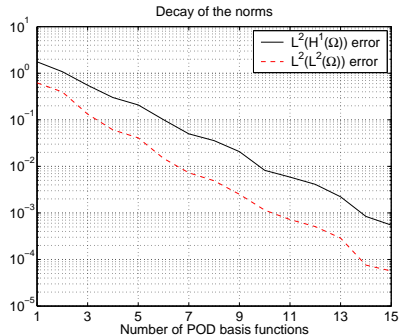
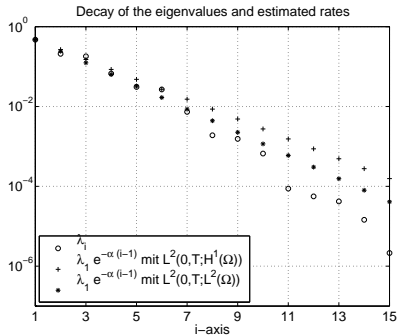

# POD for wave equation - decay of modes and error

## Decay of eigenvalues; without damping (left), and with damping (right)

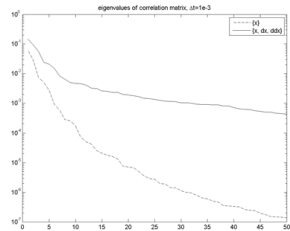
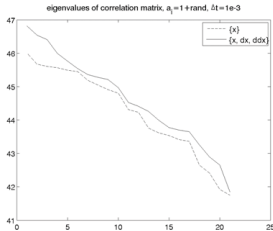

## Errors: H-modes (left) and V-modes (right), compared to Fourier analysis.

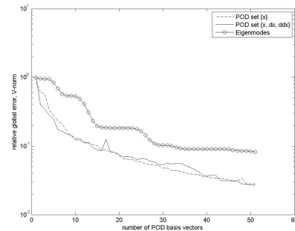
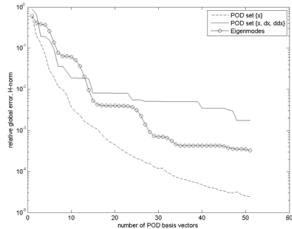

## Shortcomings of POD - non-smooth systems

### The Cahn-Hilliard system

$$\begin{aligned} \partial_t \varphi - m \Delta \mu + \mathbf{v} \cdot \nabla \varphi &= 0, \\ -\sigma \varepsilon \Delta \varphi + \sigma \varepsilon^{-1} \mathcal{F}'(\varphi) &= \mu. \end{aligned} \tag{CH}$$

weak form:

$$\begin{aligned} \langle \partial_t \varphi, \Phi \rangle + \langle \mathbf{v} \cdot \nabla \varphi, \Phi \rangle + m \langle \nabla \mu, \nabla \Phi \rangle &= 0 \\ -\langle \mu, \Psi \rangle + \sigma \varepsilon \langle \nabla \varphi, \nabla \Psi \rangle + \frac{\sigma}{\varepsilon} \langle \mathcal{F}'(\varphi), \Psi \rangle &= 0 \\ \underbrace{\hspace{15em}}_{=:\langle F(\varphi, \mu), (\Phi, \Psi) \rangle} \end{aligned}$$

relaxed Double Obstacle Energy:

$$\mathcal{F}(\varphi) = \frac{1}{2} (1 - \varphi^2)^2 + \frac{s}{k} (\max(\varphi - 1, 0) + |\min(\varphi + 1, 0)|)^k \quad k \in \mathbb{N}$$

## Decay of modes depends on the smoothness of the potential

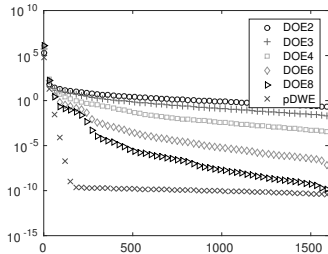
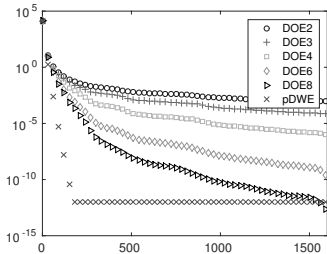

Figure: Singular values:  $\phi$  (left),  $\mu$  (right)

## Nonlinearities - DEIM by Chaturantabut and Sorensen (SISC 2010)

POD projects the nonlinearity  $\mathcal{G}(y)$  in the PDE as follows:

$$\mathcal{G}^\ell(\alpha(t)) \equiv \underbrace{\Phi^t}_{\ell \times N} \underbrace{\mathcal{G}(\Phi\alpha(t))}_{N \times 1}.$$

Here,  $\Phi$  is  $N \times \ell$ , with  $N$  the dimension of the finite element space,  $\mathcal{G}$  has  $N$  components, and in the evaluation of every of its components may touch every component of its  $N$ -dimensional argument. This evaluation thus has complexity  $\mathcal{O}(\ell N)$ .

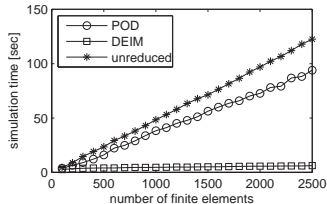

POD versus POD-DEIM in MOR for semiconductors governed by the Drift-Diffusion model

## Nonlinearities - DEIM by Chaturantabut and Sorensen (SISC 2010)

POD projects the nonlinearity  $\mathcal{G}(y)$  in the PDE as follows:

$$\mathcal{G}^\ell(\alpha(t)) \equiv \underbrace{\Phi^t}_{\ell \times N} \underbrace{\mathcal{G}(\Phi\alpha(t))}_{N \times 1}.$$

Here,  $\Phi$  is  $N \times \ell$ , with  $N$  the dimension of the finite element space,  $\mathcal{G}$  has  $N$  components, and in the evaluation of every of its components may touch every component of its  $N$ -dimensional argument. This evaluation thus has complexity  $\mathcal{O}(\ell N)$ .

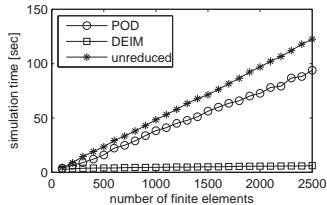

POD versus POD-DEIM in MOR for semiconductors governed by the Drift-Diffusion model

## Nonlinearities - DEIM by Chaturantabut and Sorensen (SISC 2010)

POD projects the nonlinearity  $\mathcal{G}(y)$  in the PDE as follows:

$$\mathcal{G}^\ell(\alpha(t)) \equiv \underbrace{\Phi^t}_{\ell \times N} \underbrace{\mathcal{G}(\Phi\alpha(t))}_{N \times 1}.$$

Here,  $\Phi$  is  $N \times \ell$ , with  $N$  the dimension of the finite element space,  $\mathcal{G}$  has  $N$  components, and in the evaluation of every of its components may touch every component of its  $N$ -dimensional argument. This evaluation thus has complexity  $\mathcal{O}(\ell N)$ .

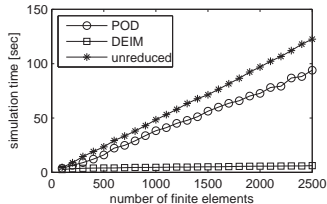

POD versus POD-DEIM in MOR for semiconductors governed by the Drift-Diffusion model

## DEIM-idea

**Approximate the nonlinear function  $\mathcal{G}(\Phi\alpha(t))$  by projecting it onto a subspace that approximates the space generated by the nonlinear function and that is spanned by a basis of dimension  $m \ll N$ .**

Here: perform a SVD with  $Y := [\mathcal{G}(y(t_1)), \dots, \mathcal{G}(y(t_n))]$  and use the first  $m$  modes  $U := [u_1, \dots, u_m]$  to interpolate

$$\mathcal{G}(\Phi\alpha(t)) \approx Uc(t).$$

This system is overdetermined.

Now DEIM selects  $m$  rows  $\rho_1, \dots, \rho_m$  from this system by a greedy procedure;

$$P^t \mathcal{G}(\Phi\alpha(t)) \approx (P^t U)c(t), \text{ where } P := [e_{\rho_1}, \dots, e_{\rho_m}] \in \mathbb{R}^{N \times m},$$

with  $P^t U$  invertible, so that  $c(t)$  is uniquely determined.

This gives

$$\mathcal{G}^\ell(\alpha(t)) \approx \underbrace{\Phi^t U (P^t U)^{-1}}_{\ell \times m} \underbrace{P^t \mathcal{G}}_{m \text{ evals}} \underbrace{(\Phi\alpha(t))}_{N \times \ell} =: \hat{\mathcal{G}}^\ell(\alpha(t))$$

with the error bound

$$\|\mathcal{G}^\ell - \hat{\mathcal{G}}^\ell\|_2 \leq \|(P^t U)^{-1}\|_2 \|(I - UU^t)\mathcal{G}^\ell\|_2.$$

Ask Serkan (now Chris?) for everything related to QDEIM.



## DEIM-idea

Approximate the nonlinear function  $\mathcal{G}(\Phi\alpha(t))$  by projecting it onto a subspace that approximates the space generated by the nonlinear function and that is spanned by a basis of dimension  $m \ll N$ .

Here: perform a SVD with  $Y := [\mathcal{G}(y(t_1)), \dots, \mathcal{G}(y(t_n))]$  and use the first  $m$  modes  $U := [u_1, \dots, u_m]$  to interpolate

$$\mathcal{G}(\Phi\alpha(t)) \approx Uc(t).$$

This system is overdetermined.

Now DEIM selects  $m$  rows  $\rho_1, \dots, \rho_m$  from this system by a greedy procedure;

$$P^t \mathcal{G}(\Phi\alpha(t)) \approx (P^t U)c(t), \text{ where } P := [e_{\rho_1}, \dots, e_{\rho_m}] \in \mathbb{R}^{N \times m},$$

with  $P^t U$  invertible, so that  $c(t)$  is uniquely determined.

This gives

$$\mathcal{G}^\ell(\alpha(t)) \approx \underbrace{\Phi^t U (P^t U)^{-1}}_{\ell \times m} \underbrace{P^t \mathcal{G}}_{m \text{ evals}} \underbrace{(\Phi\alpha(t))}_{N \times \ell} =: \hat{\mathcal{G}}^\ell(\alpha(t))$$

with the error bound

$$\|\mathcal{G}^\ell - \hat{\mathcal{G}}^\ell\|_2 \leq \|(P^t U)^{-1}\|_2 \|(I - UU^t)\mathcal{G}^\ell\|_2.$$

Ask Serkan (now Chris?) for everything related to QDEIM.

## DEIM-idea

Approximate the nonlinear function  $\mathcal{G}(\Phi\alpha(t))$  by projecting it onto a subspace that approximates the space generated by the nonlinear function and that is spanned by a basis of dimension  $m \ll N$ .

Here: perform a SVD with  $Y := [\mathcal{G}(y(t_1)), \dots, \mathcal{G}(y(t_n))]$  and use the first  $m$  modes  $U := [u_1, \dots, u_m]$  to interpolate

$$\mathcal{G}(\Phi\alpha(t)) \approx Uc(t).$$

This system is overdetermined.

Now DEIM selects  $m$  rows  $\rho_1, \dots, \rho_m$  from this system by a greedy procedure;

$$P^t \mathcal{G}(\Phi\alpha(t)) \approx (P^t U)c(t), \text{ where } P := [e_{\rho_1}, \dots, e_{\rho_m}] \in \mathbb{R}^{N \times m},$$

with  $P^t U$  invertible, so that  $c(t)$  is uniquely determined.

This gives

$$\mathcal{G}^\ell(\alpha(t)) \approx \underbrace{\Phi^t U (P^t U)^{-1}}_{\ell \times m} \underbrace{P^t \mathcal{G}}_{m \text{ evals}} \underbrace{(\Phi\alpha(t))}_{N \times \ell} =: \hat{\mathcal{G}}^\ell(\alpha(t))$$

with the error bound

$$\|\mathcal{G}^\ell - \hat{\mathcal{G}}^\ell\|_2 \leq \|(P^t U)^{-1}\|_2 \|(I - UU^t)\mathcal{G}^\ell\|_2.$$

Ask Serkan (now Chris?) for everything related to QDEIM.

## DEIM-idea

Approximate the nonlinear function  $\mathcal{G}(\Phi\alpha(t))$  by projecting it onto a subspace that approximates the space generated by the nonlinear function and that is spanned by a basis of dimension  $m \ll N$ .

Here: perform a SVD with  $Y := [\mathcal{G}(y(t_1)), \dots, \mathcal{G}(y(t_n))]$  and use the first  $m$  modes  $U := [u_1, \dots, u_m]$  to interpolate

$$\mathcal{G}(\Phi\alpha(t)) \approx Uc(t).$$

This system is overdetermined.

Now DEIM selects  $m$  rows  $\rho_1, \dots, \rho_m$  from this system by a greedy procedure;

$$P^t \mathcal{G}(\Phi\alpha(t)) \approx (P^t U)c(t), \text{ where } P := [e_{\rho_1}, \dots, e_{\rho_m}] \in \mathbb{R}^{N \times m},$$

with  $P^t U$  invertible, so that  $c(t)$  is uniquely determined.

This gives

$$\mathcal{G}^\ell(\alpha(t)) \approx \underbrace{\Phi^t U (P^t U)^{-1}}_{\ell \times m} \underbrace{P^t \mathcal{G}}_{m \text{ evals}} \underbrace{(\Phi\alpha(t))}_{N \times \ell} =: \hat{\mathcal{G}}^\ell(\alpha(t))$$

with the error bound

$$\|\mathcal{G}^\ell - \hat{\mathcal{G}}^\ell\|_2 \leq \|(P^t U)^{-1}\|_2 \|(I - UU^t)\mathcal{G}^\ell\|_2.$$

Ask Serkan (now Chris?) for everything related to QDEIM.

## DEIM-idea

Approximate the nonlinear function  $\mathcal{G}(\Phi\alpha(t))$  by projecting it onto a subspace that approximates the space generated by the nonlinear function and that is spanned by a basis of dimension  $m \ll N$ .

Here: perform a SVD with  $Y := [\mathcal{G}(y(t_1)), \dots, \mathcal{G}(y(t_n))]$  and use the first  $m$  modes  $U := [u_1, \dots, u_m]$  to interpolate

$$\mathcal{G}(\Phi\alpha(t)) \approx Uc(t).$$

This system is overdetermined.

Now DEIM selects  $m$  rows  $\rho_1, \dots, \rho_m$  from this system by a greedy procedure;

$$P^t \mathcal{G}(\Phi\alpha(t)) \approx (P^t U)c(t), \text{ where } P := [e_{\rho_1}, \dots, e_{\rho_m}] \in \mathbb{R}^{N \times m},$$

with  $P^t U$  invertible, so that  $c(t)$  is uniquely determined.

This gives

$$\mathcal{G}^\ell(\alpha(t)) \approx \underbrace{\Phi^t U (P^t U)^{-1}}_{\ell \times m} \underbrace{P^t \mathcal{G}}_{m \text{ evals}} \underbrace{(\Phi\alpha(t))}_{N \times \ell} =: \hat{\mathcal{G}}^\ell(\alpha(t))$$

with the error bound

$$\|\mathcal{G}^\ell - \hat{\mathcal{G}}^\ell\|_2 \leq \|(P^t U)^{-1}\|_2 \|(I - UU^t)\mathcal{G}^\ell\|_2.$$

Ask Serkan (now Chris?) for everything related to QDEIM.

## DEIM-idea

Approximate the nonlinear function  $\mathcal{G}(\Phi\alpha(t))$  by projecting it onto a subspace that approximates the space generated by the nonlinear function and that is spanned by a basis of dimension  $m \ll N$ .

Here: perform a SVD with  $Y := [\mathcal{G}(y(t_1)), \dots, \mathcal{G}(y(t_n))]$  and use the first  $m$  modes  $U := [u_1, \dots, u_m]$  to interpolate

$$\mathcal{G}(\Phi\alpha(t)) \approx Uc(t).$$

This system is overdetermined.

Now DEIM selects  $m$  rows  $\rho_1, \dots, \rho_m$  from this system by a greedy procedure;

$$P^t \mathcal{G}(\Phi\alpha(t)) \approx (P^t U)c(t), \text{ where } P := [e_{\rho_1}, \dots, e_{\rho_m}] \in \mathbb{R}^{N \times m},$$

with  $P^t U$  invertible, so that  $c(t)$  is uniquely determined.

This gives

$$\mathcal{G}^\ell(\alpha(t)) \approx \underbrace{\Phi^t U (P^t U)^{-1}}_{\ell \times m} \underbrace{P^t \mathcal{G}}_{m \text{ evals}} \underbrace{(\Phi\alpha(t))}_{N \times \ell} =: \hat{\mathcal{G}}^\ell(\alpha(t))$$

with the error bound

$$\|\mathcal{G}^\ell - \hat{\mathcal{G}}^\ell\|_2 \leq \|(P^t U)^{-1}\|_2 \|(I - UU^t)\mathcal{G}^\ell\|_2.$$

Ask Serkan (now Chris?) for everything related to QDEIM.

# POD-MOR and adaptive concepts

- Spatial adaptivity [Gräßle, H., 2017]

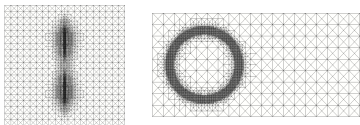

**Problem:** Snapshots are vectors of different lengths! Discussion now!

- Time adaptivity (snapshot location) [Alla, Gräßle, H., 2016]

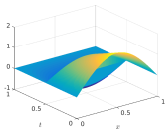

What are **suitable time instances** for the snapshots?

- POD basis updates for optimal control problems [Gräßle, Gubisch, Metzdorf, Rogg, Volkwein, 2016; Alla, Gräßle, H., 2016]

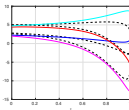

How to choose a **suitable input control** for snapshot generation?

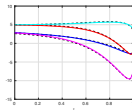

# POD-MOR and adaptive concepts

## ● Spatial adaptivity [Gräßle, H., 2017]

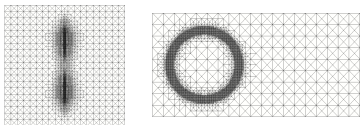

**Problem:** Snapshots are vectors of different lengths! Discussion now!

## ● Time adaptivity (snapshot location) [Alla, Gräßle, H., 2016]

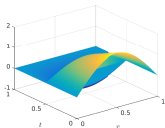

What are **suitable time instances** for the snapshots?

## ● POD basis updates for optimal control problems [Gräßle, Gubisch, Metzdorf, Rogg, Volkwein, 2016; Alla, Gräßle, H., 2016]

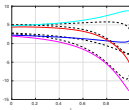

How to choose a **suitable input control** for snapshot generation?

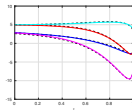

# POD-MOR and adaptive concepts

- Spatial adaptivity [Gräßle, H., 2017]

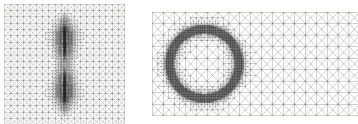

**Problem:** Snapshots are vectors of different lengths! Discussion now!

- Time adaptivity (snapshot location) [Alla, Gräßle, H., 2016]

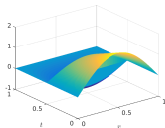

What are **suitable time instances** for the snapshots?

- POD basis updates for optimal control problems [Gräßle, Gubisch, Metzdorf, Rogg, Volkwein, 2016; Alla, Gräßle, H., 2016]

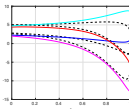

How to choose a **suitable input control** for snapshot generation?

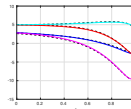



## Objectives: Simulation based optimization & MOR

$$\begin{aligned}
 \partial_t(\rho \mathbf{v}) + \operatorname{div}(\mathbf{v} \otimes \rho \mathbf{v}) - \operatorname{div}(2\eta(\varphi)\epsilon(\mathbf{v})) + \nabla \pi \\
 + \operatorname{div}(\mathbf{v} \otimes -\frac{\hat{\rho}_2 - \hat{\rho}_1}{2} \mathbf{m}(\varphi) \nabla \mu) - \mu \nabla \varphi &= \mathbf{u} \quad \text{control} \\
 \operatorname{div} \mathbf{v} &= 0 \\
 \partial_t \varphi + \mathbf{v} \nabla \varphi - \operatorname{div}(\mathbf{m}(\varphi) \nabla \mu) &= 0 \\
 -\Delta \varphi + \partial \Psi(\varphi) - \mu &= 0 \\
 \mathbf{v}|_{\partial \Omega} = \partial_n \varphi|_{\partial \Omega} = \partial_n \mu|_{\partial \Omega} &= 0 \\
 (\mathbf{v}, \varphi)|_{t=0} &= (\mathbf{v}_a, \varphi_a)
 \end{aligned}$$

non-smoothness  
 enters through  
 Cahn-Hilliard

Aim: Develop a fully integrated POD-MOR based optimization tool for multiphase flows with variable densities governed by non-smooth Cahn-Hilliard/Navier-Stokes systems

First step POD-Model Order Reduction of the Cahn-Hilliard system (Oke Alff)

## Objectives: Simulation based optimization & MOR

$$\begin{aligned}
 \partial_t(\rho \mathbf{v}) + \operatorname{div}(\mathbf{v} \otimes \rho \mathbf{v}) - \operatorname{div}(2\eta(\varphi)\epsilon(\mathbf{v})) + \nabla \pi \\
 + \operatorname{div}\left(\mathbf{v} \otimes -\frac{\hat{\rho}_2 - \hat{\rho}_1}{2} \mathbf{m}(\varphi) \nabla \mu\right) - \mu \nabla \varphi &= \mathbf{u} \quad \text{control} \\
 \operatorname{div} \mathbf{v} &= 0 \\
 \partial_t \varphi + \mathbf{v} \nabla \varphi - \operatorname{div}(\mathbf{m}(\varphi) \nabla \mu) &= 0 \\
 -\Delta \varphi + \partial \Psi(\varphi) - \mu &= 0 \\
 \mathbf{v}|_{\partial \Omega} = \partial_n \varphi|_{\partial \Omega} = \partial_n \mu|_{\partial \Omega} &= 0 \\
 (\mathbf{v}, \varphi)|_{t=0} &= (\mathbf{v}_a, \varphi_a)
 \end{aligned}$$

non-smoothness  
 enters through  
 Cahn-Hilliard

**Aim: Develop a fully integrated POD-MOR based optimization tool for multiphase flows with variable densities governed by non-smooth Cahn-Hilliard/Navier-Stokes systems**

First step POD-Model Order Reduction of the Cahn-Hilliard system (Oke Alff)

## Objectives: Simulation based optimization & MOR

$$\begin{aligned}
 \partial_t(\rho \mathbf{v}) + \operatorname{div}(\mathbf{v} \otimes \rho \mathbf{v}) - \operatorname{div}(2\eta(\varphi)\epsilon(\mathbf{v})) + \nabla \pi \\
 + \operatorname{div}(\mathbf{v} \otimes -\frac{\hat{\rho}_2 - \hat{\rho}_1}{2} \mathbf{m}(\varphi) \nabla \mu) - \mu \nabla \varphi &= \mathbf{u} \quad \text{control} \\
 \operatorname{div} \mathbf{v} &= 0 \\
 \partial_t \varphi + \mathbf{v} \nabla \varphi - \operatorname{div}(\mathbf{m}(\varphi) \nabla \mu) &= 0 \\
 -\Delta \varphi + \partial \Psi(\varphi) - \mu &= 0 \\
 \mathbf{v}|_{\partial \Omega} = \partial_n \varphi|_{\partial \Omega} = \partial_n \mu|_{\partial \Omega} &= 0 \\
 (\mathbf{v}, \varphi)|_{t=0} &= (\mathbf{v}_a, \varphi_a)
 \end{aligned}$$

non-smoothness  
 enters through  
 Cahn-Hilliard

**Aim: Develop a fully integrated POD-MOR based optimization tool for multiphase flows with variable densities governed by non-smooth Cahn-Hilliard/Navier-Stokes systems**

**First step** **POD-Model Order Reduction** of the Cahn-Hilliard system (Oke Alff)

## POD model order reduction

[L. Sirovich '87]

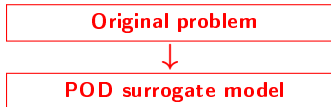

**Proper  
Orthogonal  
Decomposition**

## POD model order reduction

[L. Sirovich '87]

Original problem



POD surrogate model

Proper  
Orthogonal  
Decomposition

Procedure (discrete formulation):

$$\text{Galerkin ansatz } \mathbf{y}^\ell = \sum_{i=1}^{\ell} \eta_i \boldsymbol{\psi}_i$$

## POD model order reduction

[L. Sirovich '87]

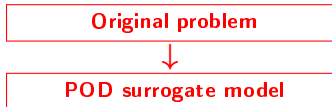

Proper  
Orthogonal  
Decomposition

### Procedure (discrete formulation):

- Choose suitable snapshots, e.g.  $Y := [y^1 \mid \dots \mid y^n] \in \mathbb{R}^{N \times n}$
- Compute POD basis  $\{\psi_1, \dots, \psi_\ell\} \subset \mathbb{R}^N$  of rank  $\ell$ : **svd**  $Y = \Psi \Sigma \Phi^T$
- Set up the Galerkin ansatz  $y^\ell = \sum_{i=1}^{\ell} \eta_i \psi_i$ , non local basis
- Surrogate model  $\rightarrow$  low dimension

## POD model order reduction

[L. Sirovich '87]

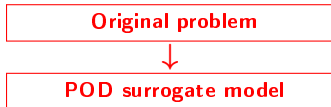

Proper  
Orthogonal  
Decomposition

### Procedure (discrete formulation):

- Choose suitable snapshots, e.g.  $Y := [y^1 | \dots | y^n] \in \mathbb{R}^{N \times n}$
- Compute POD basis  $\{\psi_1, \dots, \psi_\ell\} \subset \mathbb{R}^N$  of rank  $\ell$ : **svd**  $Y = \Psi \Sigma \Phi^T$
- Set up the Galerkin ansatz  $y^\ell = \sum_{i=1}^{\ell} \eta_i \psi_i$ , non local basis
- Surrogate model  $\rightarrow$  low dimension

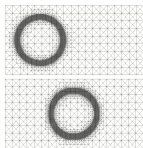

## POD model order reduction

[L. Sirovich '87]



### Procedure (discrete formulation):

- Choose suitable snapshots, e.g.  $Y := [y^1 | \dots | y^n] \in \mathbb{R}^{N \times n}$
- Compute POD basis  $\{\psi_1, \dots, \psi_\ell\} \subset \mathbb{R}^N$  of rank  $\ell$ : **svd**  $Y = \Psi \Sigma \Phi^T$
- Set up the Galerkin ansatz  $y^\ell = \sum_{i=1}^{\ell} \eta_i \psi_i$ , non local basis
- Surrogate model  $\rightarrow$  low dimension

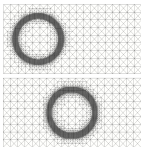

Require: adaptivity in spatial discretization:  
**Snapshots are vectors of different lengths!**



## POD model order reduction

[L. Sirovich '87]

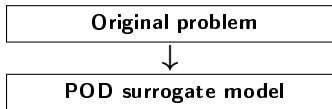

Proper  
Orthogonal  
Decomposition

### Procedure (continuous formulation):

- Choose suitable snapshots,  $y^1 \in V^1, \dots, y^n \in V^n, V^1, \dots, V^n \subset X$
- Compute POD basis  $\{\psi_1, \dots, \psi_\ell\} \subset X$  of rank  $\ell$
- Set up the Galerkin ansatz  $y^\ell = \sum_{i=1}^{\ell} \eta_i \psi_i$ , non local basis
- Surrogate model  $\rightarrow$  low dimension

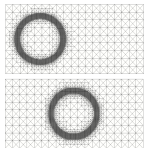

Require: adaptivity in spatial discretization:  
~~Snapshots are vectors of different lengths!~~

## Related literature

- [F. Fang et al.](#) *Reduced-order modelling of an adaptive mesh ocean model*, 2009
- [O. Lass.](#) *Reduced order modeling and parameter identification for coupled nonlinear PDE systems*, 2014
- [M. Ali, K. Steih, K. Urban.](#) *Reduced basis methods based upon adaptive snapshot computations*, 2014
- [M. Yano.](#) *A minimum-residual mixed reduced basis method: exact residual certification and simultaneous finite-element reduced-basis refinement*, 2016
- [S. Ullmann, M. Rotkvic, J. Lang.](#) *POD-Galerkin reduced-order modeling with adaptive finite element snapshots*, 2016
- [C. Gräßle, M. Hinze.](#) *POD reduced order modeling for evolution equations utilizing arbitrary finite element discretizations*, 2017

## POD: $\infty$ -dimensional perspective

**Given:** **Snapshots**  $y^1 \in V^1, \dots, y^n \in V^n, \dots$ , e.g.  $y^j = y(t_j), j = 1, \dots, n$   
 $V^1, \dots, V^n \subset V \subset X$  arbitrary finite element spaces ( $X = V$  or  $H$ )  
**Aim:** Determine **POD basis**  $\{\psi_1, \dots, \psi_\ell\}$  of rank  $\ell$  solving

$$(\star) \quad \min_{\psi_1, \dots, \psi_\ell \in X} \sum_{m=0}^n \alpha_m \left\| y^m - \sum_{i=1}^{\ell} \langle y^m, \psi_i \rangle_X \psi_i \right\|_X^2 \quad \text{s.t.} \quad \langle \psi_i, \psi_j \rangle_X = \delta_{ij}$$

**Introduce:**  $\mathcal{Y} : \mathbb{R}^n \rightarrow X, \mathcal{Y}\phi = \sum_{m=1}^n \sqrt{\alpha_m} \phi_m y^m$  for  $\phi \in \mathbb{R}^n$ .

$\mathcal{Y}^* : X \rightarrow \mathbb{R}^n, \mathcal{Y}^*\psi = (\langle \psi, \sqrt{\alpha_1} y^1 \rangle_X, \dots, \langle \psi, \sqrt{\alpha_n} y^n \rangle_X)^T$  for  $\psi \in X$ .

A solution to  $(\star)$  is given by the first  $\ell$  eigenvectors of  $\mathcal{R} = \mathcal{Y}\mathcal{Y}^* : X \rightarrow X$ , with

$$\mathcal{R}\psi = \sum_{m=1}^n \alpha_m \langle \psi, y^m \rangle_X y^m \quad \text{for } \psi \in X.$$

$\mathcal{K} = \mathcal{Y}^*\mathcal{Y} : \mathbb{R}^n \rightarrow \mathbb{R}^n$  with  $\mathcal{K}_{ij} = (\sqrt{\alpha_i \alpha_j} \langle y^i, y^j \rangle_X)$  has the same eigenvalues as  $\mathcal{R}$  (except for possibly zero).  $\mathcal{K}_{ij} = \sqrt{\alpha_i \alpha_j} \sum_{k=1}^{N_i} \sum_{l=1}^{N_j} y_k^i y_l^j \langle v_k^i, v_l^j \rangle_X$

## POD: $\infty$ -dimensional perspective

**Given:** **Snapshots**  $y^1 \in V^1, \dots, y^n \in V^n, \dots$ , e.g.  $y^j = y(t_j), j = 1, \dots, n$   
 $V^1, \dots, V^n \subset V \subset X$  arbitrary finite element spaces ( $X = V$  or  $H$ )  
**Aim:** Determine **POD basis**  $\{\psi_1, \dots, \psi_\ell\}$  of rank  $\ell$  solving

$$(\star) \quad \min_{\psi_1, \dots, \psi_\ell \in X} \sum_{m=0}^n \alpha_m \left\| y^m - \sum_{i=1}^{\ell} \langle y^m, \psi_i \rangle_X \psi_i \right\|_X^2 \quad \text{s.t.} \quad \langle \psi_i, \psi_j \rangle_X = \delta_{ij}$$

**Introduce:**  $\mathcal{Y} : \mathbb{R}^n \rightarrow X$ ,  $\mathcal{Y}\phi = \sum_{m=1}^n \sqrt{\alpha_m} \phi_m y^m$  for  $\phi \in \mathbb{R}^n$ .

$\mathcal{Y}^* : X \rightarrow \mathbb{R}^n$ ,  $\mathcal{Y}^*\psi = (\langle \psi, \sqrt{\alpha_1} y^1 \rangle_X, \dots, \langle \psi, \sqrt{\alpha_n} y^n \rangle_X)^T$  for  $\psi \in X$ .

**A solution to  $(\star)$**  is given by the first  $\ell$  eigenvectors of  $\mathcal{R} = \mathcal{Y}\mathcal{Y}^* : X \rightarrow X$ , with

$$\mathcal{R}\psi = \sum_{m=1}^n \alpha_m \langle \psi, y^m \rangle_X y^m \quad \text{for } \psi \in X.$$

$\mathcal{K} = \mathcal{Y}^*\mathcal{Y} : \mathbb{R}^n \rightarrow \mathbb{R}^n$  with  $\mathcal{K}_{ij} = (\sqrt{\alpha_i \alpha_j} \langle y^i, y^j \rangle_X)$  has the same eigenvalues as  $\mathcal{R}$  (except for possibly zero).  $\mathcal{K}_{ij} = \sqrt{\alpha_i \alpha_j} \sum_{k=1}^{N_i} \sum_{l=1}^{N_j} y_k^i y_l^j \langle v_k^i, v_l^j \rangle_X$

## POD: $\infty$ -dimensional perspective

**Given:** **Snapshots**  $y^1 \in V^1, \dots, y^n \in V^n, \dots$ , e.g.  $y^j = y(t_j), j = 1, \dots, n$   
 $V^1, \dots, V^n \subset V \subset X$  arbitrary finite element spaces ( $X = V$  or  $H$ )  
**Aim:** Determine **POD basis**  $\{\psi_1, \dots, \psi_\ell\}$  of rank  $\ell$  solving

$$(\star) \quad \min_{\psi_1, \dots, \psi_\ell \in X} \sum_{m=0}^n \alpha_m \left\| y^m - \sum_{i=1}^{\ell} \langle y^m, \psi_i \rangle_X \psi_i \right\|_X^2 \quad \text{s.t.} \quad \langle \psi_i, \psi_j \rangle_X = \delta_{ij}$$

**Introduce:**  $\mathcal{Y} : \mathbb{R}^n \rightarrow X$ ,  $\mathcal{Y}\phi = \sum_{m=1}^n \sqrt{\alpha_m} \phi_m y^m$  for  $\phi \in \mathbb{R}^n$ .

$\mathcal{Y}^* : X \rightarrow \mathbb{R}^n$ ,  $\mathcal{Y}^*\psi = (\langle \psi, \sqrt{\alpha_1} y^1 \rangle_X, \dots, \langle \psi, \sqrt{\alpha_n} y^n \rangle_X)^T$  for  $\psi \in X$ .

**A solution to  $(\star)$**  is given by the first  $\ell$  eigenvectors of  $\mathcal{R} = \mathcal{Y}\mathcal{Y}^* : X \rightarrow X$ , with

$$\mathcal{R}\psi = \sum_{m=1}^n \alpha_m \langle \psi, y^m \rangle_X y^m \quad \text{for } \psi \in X.$$

$\mathcal{K} = \mathcal{Y}^*\mathcal{Y} : \mathbb{R}^n \rightarrow \mathbb{R}^n$  with  $\mathcal{K}_{ij} = (\sqrt{\alpha_i \alpha_j} \langle y^i, y^j \rangle_X)$  has the same eigenvalues as  $\mathcal{R}$  (except for possibly zero).  $\mathcal{K}_{ij} = \sqrt{\alpha_i \alpha_j} \sum_{k=1}^{N_i} \sum_{l=1}^{N_j} y_k^i y_l^j \langle v_k^i, v_l^j \rangle_X$

## POD: $\infty$ -dimensional perspective

$\mathcal{K} = \mathcal{Y}^* \mathcal{Y} : \mathbb{R}^n \rightarrow \mathbb{R}^n$  with  $\mathcal{K}_{ij} = (\sqrt{\alpha_i \alpha_j} \langle y^i, y^j \rangle_x)$  has the same eigenvalues as  $\mathcal{R}$  (except for possibly zero).  $\mathcal{K}_{ij} = \sqrt{\alpha_i \alpha_j} \sum_{k=1}^{N_i} \sum_{l=1}^{N_j} y_k^i y_l^j \langle v_k^i, v_l^j \rangle_x$

For building  $\mathcal{K}$  we only need to be able to compute the entries

$$\mathcal{K}_{ij} = \sqrt{\alpha_i \alpha_j} \sum_{k=1}^{N_i} \sum_{l=1}^{N_j} y_k^i y_l^j \langle v_k^i, v_l^j \rangle_x$$

Then we obtain the modes  $\psi_j$  according to

$$\psi_j = \frac{1}{\sqrt{\lambda_j}} \mathcal{Y} \phi_j$$

with  $(\lambda_j, \phi_j)$  the eigensystem of  $\mathcal{K}$ .

## POD: $\infty$ -dimensional perspective

$\mathcal{K} = \mathcal{Y}^* \mathcal{Y} : \mathbb{R}^n \rightarrow \mathbb{R}^n$  with  $\mathcal{K}_{ij} = (\sqrt{\alpha_i \alpha_j} \langle y^i, y^j \rangle_X)$  has the same eigenvalues as  $\mathcal{R}$  (except for possibly zero).  $\mathcal{K}_{ij} = \sqrt{\alpha_i \alpha_j} \sum_{k=1}^{N_i} \sum_{l=1}^{N_j} y_k^i y_l^j \langle v_k^i, v_l^j \rangle_X$

For building  $\mathcal{K}$  we only need to be able to compute the entries

$$\mathcal{K}_{ij} = \sqrt{\alpha_i \alpha_j} \sum_{k=1}^{N_i} \sum_{l=1}^{N_j} y_k^i y_l^j \langle v_k^i, v_l^j \rangle_X$$

Then we obtain the modes  $\psi_j$  according to

$$\psi_j = \frac{1}{\sqrt{\lambda_j}} \mathcal{Y} \phi_j$$

with  $(\lambda_j, \phi_j)$  the eigensystem of  $\mathcal{K}$ .

## POD reduced order modeling for evolution equations

$$\begin{cases} \frac{d}{dt} \langle \mathbf{y}(t), \mathbf{v} \rangle_H + \mathbf{a}(\mathbf{y}(t), \mathbf{v}) + \langle \mathcal{N}(\mathbf{y}(t)), \mathbf{v} \rangle_{V', V} &= \langle \mathbf{f}(t), \mathbf{v} \rangle_{V', V}, \\ \langle \mathbf{y}(0), \mathbf{v} \rangle_H &= \langle \mathbf{y}_0, \mathbf{v} \rangle_H, \end{cases}$$

**POD Galerkin ansatz:**  $\mathbf{y}^\ell(t) = \sum_{i=1}^{\ell} \eta_i(t) \psi_i = \sum_{i=1}^{\ell} \eta_i(t) \frac{1}{\sqrt{\lambda_i}} \mathcal{Y} \phi_i \quad \forall t \in [0, T].$

Choose  $X^\ell = \text{span}\{\psi_1, \dots, \psi_\ell\} \subset X$  as the test space.

$$\text{ROM: } \begin{cases} D\Phi^T \mathcal{K} \Phi D \dot{\eta}(t) + D\Phi^T \mathcal{Y}^* \mathcal{A} \mathcal{Y} \Phi D \eta(t) + DN(\eta(t)) &= DF(t), \\ D\Phi^T \mathcal{K} \Phi D \eta(0) &= D\bar{\eta}_0. \end{cases}$$



## POD reduced order modeling for evolution equations

$$\begin{cases} \frac{d}{dt} \langle \mathbf{y}(t), \mathbf{v} \rangle_H + a(\mathbf{y}(t), \mathbf{v}) + \langle \mathcal{N}(\mathbf{y}(t)), \mathbf{v} \rangle_{V', V} &= \langle \mathbf{f}(t), \mathbf{v} \rangle_{V', V}, \\ \langle \mathbf{y}(0), \mathbf{v} \rangle_H &= \langle \mathbf{y}_0, \mathbf{v} \rangle_H, \end{cases}$$

**POD Galerkin ansatz:**  $\mathbf{y}^\ell(t) = \sum_{i=1}^{\ell} \eta_i(t) \psi_i = \sum_{i=1}^{\ell} \eta_i(t) \frac{1}{\sqrt{\lambda_i}} \mathcal{Y} \phi_i \quad \forall t \in [0, T].$

Choose  $X^\ell = \text{span}\{\psi_1, \dots, \psi_\ell\} \subset X$  as the test space.

$$\text{ROM: } \begin{cases} D\Phi^T \mathcal{K} \Phi D \dot{\eta}(t) + D\Phi^T \mathcal{Y}^* \mathcal{A} \mathcal{Y} \Phi D \eta(t) + DN(\eta(t)) &= DF(t), \\ D\Phi^T \mathcal{K} \Phi D \eta(0) &= D\bar{\eta}_0. \end{cases}$$

## Error estimate

**Theorem.** Let  $\mathcal{N}$  be Lipschitz continuous,  $\Delta t := \max_{j=1, \dots, n} \Delta t_j$  sufficiently small and  $\ddot{y}(t)$  be bounded on  $[0, T]$ . We choose  $y_0^\ell := \mathcal{P}^\ell y_0$ . Then, there exists a constant  $C > 0$  such that

$$\sum_{j=1}^n \alpha_j \|y(t_j) - y_j^\ell\|_H^2 \leq C((\Delta t)^2 + \varepsilon_h^2 + \sum_{i=\ell+1}^d \lambda_i + \sum_{j=1}^n \alpha_j \|\mathcal{P}^\ell \dot{y}(t_j) - \dot{y}(t_j)\|_H^2),$$

where  $\varepsilon_h$  denotes the maximum of the spatial discretization errors.

## Discussion of the nonlinear term - DEIM or Lagrange interpolation

**Given: Snapshots for the nonlinearity:**  $\mathcal{N}(y^1) \in (V^1)', \dots, \mathcal{N}(y^n) \in (V^n)'.$

**Introduce:**  $\tilde{\mathcal{Y}} : \mathbb{R}^n \rightarrow X', \tilde{\mathcal{Y}}\tilde{\phi} = \sum_{j=1}^n \sqrt{\alpha_j} \tilde{\phi}_j \mathcal{N}(y^j)$

$\tilde{\mathcal{Y}}^* : X' \rightarrow \mathbb{R}^n, \tilde{\mathcal{Y}}^*\tilde{\psi} =$   
 $(\langle \tilde{\psi}, \sqrt{\alpha_1} \mathcal{N}(y^1) \rangle_{X'}, \dots, \langle \tilde{\psi}, \sqrt{\alpha_n} \mathcal{N}(y^n) \rangle_{X'})^T$

$\tilde{\mathcal{K}} := \tilde{\mathcal{Y}}^* \tilde{\mathcal{Y}}, \tilde{\mathcal{R}} := \tilde{\mathcal{Y}} \tilde{\mathcal{Y}}^*.$

**Step 1:** Compute eigenvectors  $\{\tilde{\phi}_i\}_{i=1}^{\tilde{\ell}}$  of  $\tilde{\mathcal{K}}$  corresponding to snapshots for the nonlinearity and set  $\tilde{\psi}_i = \frac{1}{\sqrt{\tilde{\lambda}_i}} \tilde{\mathcal{Y}} \tilde{\phi}_i.$

**Step 2:** Galerkin ansatz for the nonlinearity:  $\mathcal{N}(y^\ell(t)) \approx \sum_{i=1}^{\tilde{\ell}} \beta_i(t) \tilde{\psi}_i$   
 with  $\{\beta_i(t)\}_{i=1}^{\tilde{\ell}}$  continuous and piecewise linear.

**Step 3:** Postulate interpolation property w.r.t. time and projection onto  $X^\ell$ :  $\sum_{i=1}^{\tilde{\ell}} \beta_i(t_j) \langle \tilde{\psi}_i, \psi \rangle_{X', X} = \langle \mathcal{N}(y^j), \psi \rangle_{X', X} \quad \forall \psi \in X^\ell.$

**Approximation:**  $DN(\eta(t)) \approx D\Phi^T N\tilde{\Phi}\tilde{D}\beta(t), \quad N_{ij} = \sqrt{\alpha_i \alpha_j} \langle \mathcal{N}(y^i), y^j \rangle_{X', X}.$

## Numerical test results: Cahn-Hilliard equation

$$\begin{aligned}
 \partial_t \varphi + \mathbf{v} \cdot \nabla \varphi - \operatorname{div}(\mathbf{m}(\varphi) \nabla \mu) &= \mathbf{0} \\
 -\sigma \varepsilon \Delta \varphi + \frac{\sigma}{\varepsilon} \partial \Psi(\varphi) - \mu &= \mathbf{0} \\
 \partial_n \varphi|_{\partial \Omega} = \partial_n \mu|_{\partial \Omega} &= \mathbf{0} \\
 \varphi|_{t=0} &= \varphi_a
 \end{aligned}$$

### Free energy functions:

- polynomial:  $\Psi_p(\varphi) = \frac{1}{4}(1 - \varphi^2)^2$
- double obstacle:
 
$$\Psi_\infty(\varphi) = \begin{cases} \frac{1}{2}(1 - \varphi^2), & \text{if } \varphi \in [-1, 1] \\ +\infty, & \text{else} \end{cases}$$

- relaxed double obstacle (Moreau-Yosida, [Hintermüller, Hinze, Tber, 2011]):

$$\Psi_{\text{rel}}(\varphi) = \frac{1}{2}(1 - \varphi^2) + \frac{s}{k}(\max(\varphi - 1, 0) + |\min(\varphi + 1, 0)|)^k$$

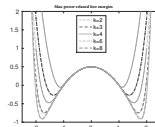
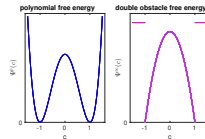
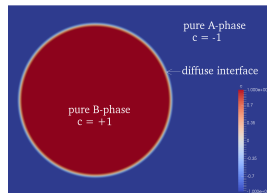

## Numerical test results: Cahn-Hilliard equation

$$\begin{aligned}
 \partial_t \varphi + \mathbf{v} \cdot \nabla \varphi - \operatorname{div}(\mathbf{m}(\varphi) \nabla \mu) &= 0 \\
 -\sigma \varepsilon \Delta \varphi + \frac{\sigma}{\varepsilon} \partial \Psi(\varphi) - \mu &= 0 \\
 \partial_n \varphi|_{\partial \Omega} = \partial_n \mu|_{\partial \Omega} &= 0 \\
 \varphi|_{t=0} &= \varphi_a
 \end{aligned}$$

### Free energy functions:

- **polynomial:**  $\Psi_p(\varphi) = \frac{1}{4}(1 - \varphi^2)^2$
- **double obstacle:**

$$\Psi_\infty(\varphi) = \begin{cases} \frac{1}{2}(1 - \varphi^2), & \text{if } \varphi \in [-1, 1] \\ +\infty, & \text{else} \end{cases}$$
- **relaxed double obstacle (Moreau-Yosida, [Hintermüller, Hinze, Tber, 2011]):**

$$\Psi_{\text{rel}}(\varphi) = \frac{1}{2}(1 - \varphi^2) + \frac{s}{k}(\max(\varphi - 1, 0) + |\min(\varphi + 1, 0)|)^k$$

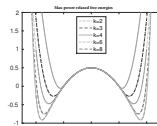
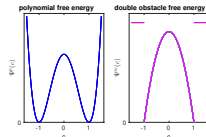
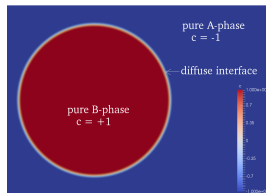

# Singular value decay for max-power relaxation (numerics Oke ALff)

## Computations on a uniform grid.

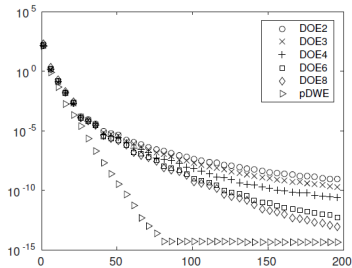

(a)  $\varphi$

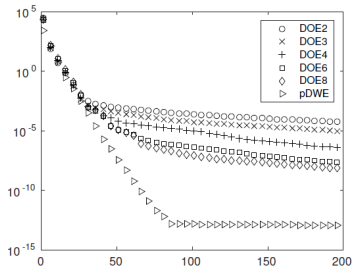

(b)  $\mu$

- Behaviour similar to Fourier analysis.
- Relaxation of max according to Hintermüller/Kopacka (2011) gives better results.

# Simulation and adaptive grids

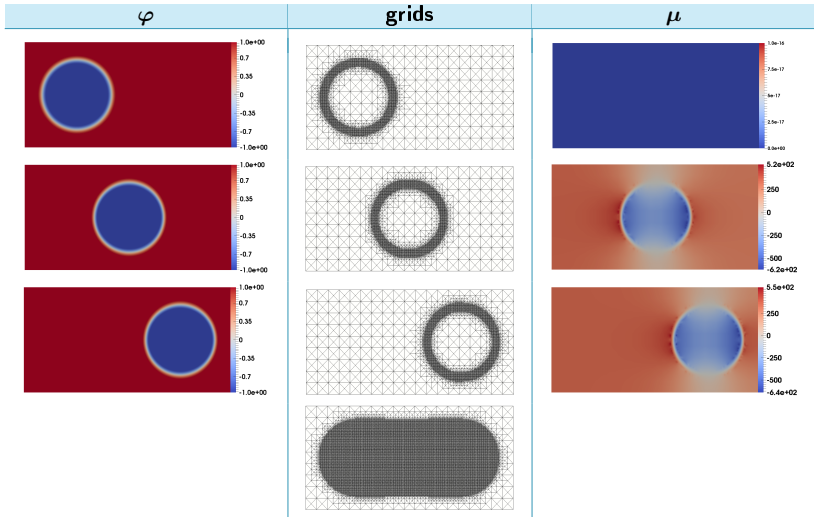

## Decay of eigenvalues

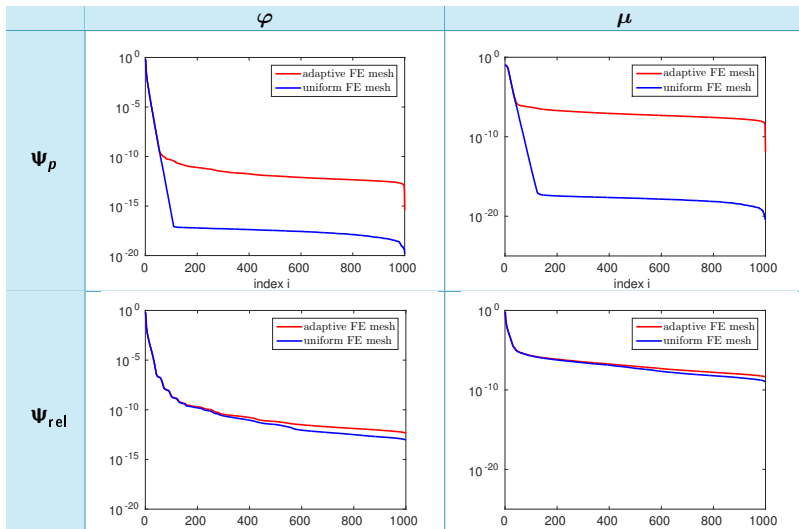



## Relative $L^2$ -errors and computation times

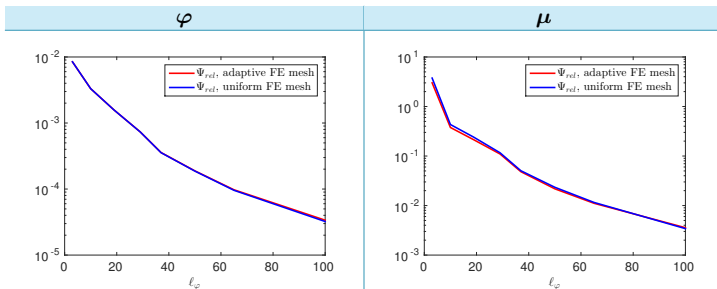

$\Psi_p$	adaptive FE mesh	uniform FE mesh	speedup factor
FE simulation	1499 sec	8279 sec	5.5
POD offline	352 sec	550 sec	1.5
POD simulation	183 sec	271 sec	1.5
speedup factor	8	30.5	

## Lecture 2: Optimization with POD surrogate models

**The beginnings of POD-based flow control**

**Motivation: PDE constrained optimization**

**Mathematical setting**

**Construction of the POD spaces**

**Basic approach in PDE constrained optimization**

**Numerical analysis of POD in PDE constrained optimization**

**Snapshot choice in optimal control**

**Further aspects of POD in applications**

## Optimization with the reduced model - the beginnings

**Model optimization problem:**

$$\min_{(y,u) \in W \times U} J(y, u) := \frac{1}{2} \int_{Q_o} |y - z|^2 \, dx dt + \frac{\gamma}{2} \|u\|_U^2$$

s. t.

$$\begin{aligned} \frac{\partial y}{\partial t} + (y \cdot \nabla) y - \nu \Delta y + \nabla p &= Bu \text{ in } Q = (0, T) \times \Omega, \\ -\operatorname{div} y &= 0 \text{ in } Q, \\ y(t, \cdot) &= 0 \text{ on } \Sigma = (0, T) \times \partial\Omega, \\ y(0, \cdot) &= y_0 \text{ in } \Omega. \end{aligned}$$

Here,  $B : U \rightarrow L^2(0, T; H^{-1}(\Omega)^d)$  denotes the control operator. It is also possible to consider the initial values as control.

Typical control operator is extension

$B : L^2(0, T; L^2(\Omega_c)^d) \rightarrow L^2(0, T; H^{-1}(\Omega)^d)$ . Observation cylinder is given by  $Q_o := (0, T) \times \Omega_o$ .

## POD model as pde surrogate in the optimization problem

Ansatz for state (and the desired state)

$$y = \bar{y} + \sum_{i=1}^n \alpha_i \Phi_i, \quad z = \bar{y} + \sum_{i=1}^n \alpha_i^z \Phi_i.$$

Optimization problem with POD surrogate model

$$\min_{(y,u)} J(y,u) = J(\alpha,u) = \frac{1}{2} \int_0^T (\alpha - \alpha^z)^t \mathcal{M}_1(\alpha - \alpha^z) dt + \frac{\gamma}{2} \|u\|_U^2$$

s. t.

$$\begin{aligned} \dot{\alpha} + A\alpha + n(\alpha) &= r + \mathcal{B}u, \\ \alpha(0) &= a_0. \end{aligned}$$

## Validity of surrogate model

**Fact:**

**Control changes system dynamics.**

**Consequence:**

**Mean and modes should be suitably modified during the optimization process.**

**Idea:**

**Adaptively modify the surrogate model and thus, the reduced optimization problems.**

## Adaptive POD control – Afanasiev, Hinze 1999

- 1 Snapshots  $y_i^0, i = 1, \dots, N_0$  given,  $u^0$  given control,  $\delta \in [0, 1]$  required relative information content,  $j=0$ .

2 Compute  $M = \operatorname{argmin} \left\{ I(M) := \frac{\sum_{k=1}^M \lambda_k}{\sum_{k=1}^N \lambda_k}; I(M) \geq \delta \right\}$ .

- 3 Compute POD modes and solve

$$(\text{ROM}) \begin{cases} \min J(\alpha, u) \\ \text{s.t.} \\ \dot{\alpha} + A\alpha + n(\alpha) = Bu, \quad \alpha(0) = a_0. \end{cases}$$

for  $u^j$ .

- 4 Compute  $y^j$  corresponding to  $Bu^j$  and new snapshots  $y_i^{j+1}, i = N_j + 1, \dots, N_{j+1}$  to the snapshot set  $y_i^j, i = 1, \dots, N_j$ .
- 5 While  $\|u^{j+1} - u^j\|_U$  is large,  $j = j+1$  and goto 2.

## Numerical comparison

Flow around a circular cylinder at  $Re=100$ . Control gain: Tracking of Stokes flow (or mean flow)  $\bar{y}$  in an observation volume  $\Omega_{obs}$  behind the cylinder by applying a volume force in the control volume  $\Omega_c$ .

Cost functional:

$$J(y, u) = \frac{\gamma}{2} \int_0^T \int_{\Omega_c} |u|^2 dxdt + \frac{1}{2} \int_0^T \int_{\Omega_{obs}} |y - \bar{y}|^2 dxdt$$

CPU time needed to compute the suboptimal controls  $\approx$  **40 times smaller** than that needed to compute the optimal open loop control. But the quality of the controls is very similar.

$$\text{Runtime(Optimization Problem)} = \mathbf{6 - 8} \times \text{Runtime(PDE)}$$

Uncontrolled flow, target flow = mean flow, controlled flow at  $t = 3.4$ .

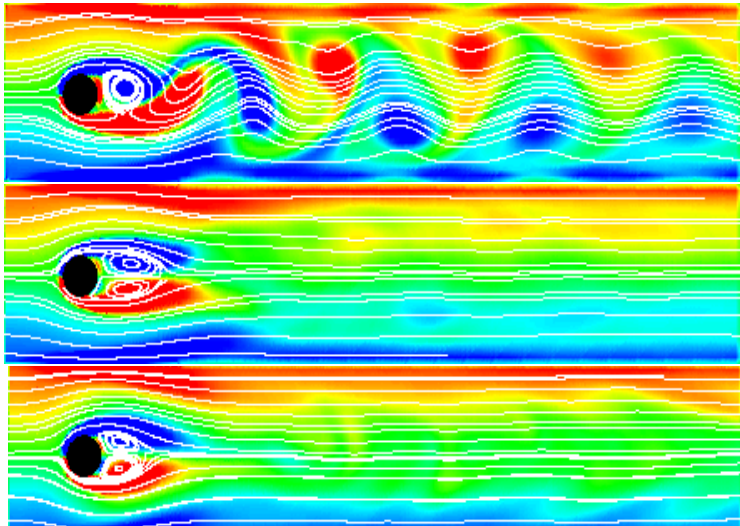





## Motivation: optimization problem with pde constraints

$$\min_{(y,u) \in W \times U_{ad}} J(y, u) \text{ s.t.}$$

$$\frac{\partial y}{\partial t} + \mathcal{A}y + \mathcal{G}(y) = Bu \text{ in } Z^*$$

$$y(0) = y_0 \text{ in } H.$$

Approach: Solve this problem by using a POD surrogate model;

$$\min_{(y',u') \in W' \times U_{ad}} J'(y', u') \text{ s.t.}$$

$$\frac{\partial y'}{\partial t} + \mathcal{A}'y' + \mathcal{G}'(y') = Bu' \text{ in } (Z')^*$$

$$y'(0) = y'_0 \text{ in } H'.$$

Tasks:

- Error estimation,
- adaption of the POD surrogate model during the optimization loop.

## Mathematical setting, state equation

- $V, H$  separable Hilbert spaces,  $(V, H = H^*, V^*)$  Gelfand triple.

- $a : V \times V \rightarrow \mathbb{R}$  bounded, coercive and symmetric. Set

$$\langle \bullet, \bullet \rangle_V := a(\bullet, \bullet).$$

- $U$  Hilbert space,  $B : U \rightarrow \mathcal{L}^2(U, L^2(V^*))$  linear control operator,  $y_0 \in H$ .

- State equation

$$\begin{aligned} \frac{d}{dt} (y(t), v)_H + a(y(t), v) &= \langle (Bu)(t), v \rangle_{V, V^*}, & t \in [0, T], v \in V, \\ (y(0), v)_H &= (y_0, v)_H, & v \in V. \end{aligned}$$

- For every  $u \in U$  the solution  $y = y(u) \in W := \{w \in L^2(V), w_t \in L^2(V^*)\}$  is unique.

## Optimization problem

- **Cost functional**

$$J(y, u) := \frac{1}{2} \|y - z\|_{L^2(H)}^2 + \frac{\alpha}{2} \|u\|_U^2.$$

- **Admissibility:**  $u \in U_{\text{ad}} \subseteq U$  closed, convex,  $y \equiv y(u)$  unique solution of state equation associated to  $u$ , i.e.

$$\begin{aligned} \frac{d}{dt} (y(t), v)_H + a(y(t), v) &= \langle (Bu)(t), v \rangle_{V, V^*}, & t \in [0, T], v \in V, \\ (y(0), v)_H &= (y_0, v)_H, & v \in V. \end{aligned}$$

- **Minimization problem:**

$$(P) \quad \min_{(y, u) \in W(0, T) \times U_{\text{ad}}} J(y, u) \text{ s.t. Admissibility.}$$

- $(P)$  admits a unique solution  $(y, u) \in W \times U_{\text{ad}}$ .

## Optimality conditions

- With the reduced cost functional  $\hat{J}(u) := J(y(u), u)$  there holds

$$\left( \hat{J}'(u), v - u \right) \geq 0 \text{ for all } v \in U_{\text{ad}}.$$

- Here

$$\hat{J}'(u) = \alpha u + B^* p(y(u)).$$

- The function  $p$  solves the adjoint equation

$$\begin{aligned} -\frac{d}{dt} (p(t), v)_H + a(v, p(t)) &= (y - z, v)_H, & t \in [0, T], v \in V, \\ (p(T), v)_H &= 0, & v \in V. \end{aligned}$$

- Variational inequality equivalent to nonsmooth operator equation

$$u = P_{U_{\text{ad}}} \left( -\frac{1}{\alpha} B^* p(y(u)) \right)$$

with  $P_{U_{\text{ad}}}$  denoting the orthogonal projection onto  $U_{\text{ad}}$ .

## Discrete concept for the state equation

- For  $l \in \mathbb{N}$  choose a POD subspace  $V^l := \langle \chi_1, \dots, \chi_l \rangle$  of  $V$  with the property

$$\|y(t) - \sum_{k=1}^l (y(t), \chi_k)_V \chi_k\|_{W(0,T)}^2 \sim \sum_{k=l+1}^{\infty} \lambda_k.$$

- Galerkin semi-discretization  $y^l$  of state  $y$  using subspace  $V^l$ :

$$\begin{aligned} \frac{d}{dt} (y^l(t), v)_H + a(y^l(t), v) &= \langle (Bu)(t), v \rangle_{V, V^*}, & t \in [0, T], v \in V^l, \\ (y(0), v)_H &= (y_0, v)_H, & v \in V^l. \end{aligned}$$

- If needed, define similarly a Galerkin semi-discretization  $p^l$  of  $p$ :

$$\begin{aligned} -\frac{d}{dt} (p^l(t), v)_H + a(v, p^l(t)) &= (y^l - z, v)_H, & t \in [0, T], v \in V^l, \\ (p^l(T), v)_H &= 0, & v \in V^l. \end{aligned}$$

## Optimization problem with POD surrogate model

- Discrete minimization problem:

$$(\hat{P}^l) \quad \min_{u \in U_{\text{ad}}} \hat{J}^l(u) := J(y^l(u), u).$$

- $(\hat{P}^l)$  admits a unique solution  $u^l \in U_{\text{ad}}$ .

- Optimality condition:

$$(\hat{J}'^l(u), v - u^l) \geq 0 \text{ for all } v \in U_{\text{ad}}.$$

- Here

$$\hat{J}'^l(u) = \alpha u + B^* p^l(y^l(u)).$$

- The function  $p^l$  solves the adjoint equation

$$\begin{aligned} -\frac{d}{dt} (p^l(t), v)_H + a(v, p^l(t)) &= (y^l - z, v)_H, & t \in [0, T], v \in V^l, \\ (p^l(T), v)_H &= 0, & v \in V^l. \end{aligned}$$

- Variational inequality equivalent to nonsmooth operator equation

$$u^l = P_{U_{\text{ad}}} \left( -\frac{1}{\alpha} B^* p^l(y^l(u)) \right).$$

## Error estimate

**Theorem:** Let  $u, u^l$  denote the unique solutions of  $(P)$  and  $(\hat{P}^l)$ , respectively. Then

$$\|u - u^l\|_U^2 \leq \frac{1}{\alpha} \left\{ \left( B^*(\rho(y(u)) - \rho^l(y(u))), u^l - u \right)_U + \int_0^T \left( y'(u^l) - y'(u), y(u) - y^l(u) \right)_H dt \right\}$$

Using the analysis of Kunisch and Volkwein for POD approximations one gets

$$\|u - u^l\|_U \sim \|y_0 - P^l y_0\|_H + \sqrt{\sum_{k=l+1}^{\infty} \lambda_k} + \|y_t - \mathcal{P}^\ell y_t\|_{L^2(0, T; V')} + \|\rho(y(u)) - P^l(\rho(y(u)))\|_{W(0, T)}$$



## Conclusions from the analysis

- Get rid of  $\|(y - \mathcal{P}^\ell y)_t\|_{L^2(0, T; V')}$  → include derivative information into your snapshot set.
- Get rid of  $\|p - \mathcal{P}^\ell p\|_{W(0, T)}^2$  → include adjoint information into your snapshot set.

### Recipe:

For  $l \in \mathbb{N}$  choose a POD subspace  $V^l := \langle \chi_1, \dots, \chi_l \rangle$  of  $V$  with the property

$$\|y(t) - \sum_{k=1}^l (y(t), \chi_k)_V \chi_k\|_{W(0, T)}^2 \sim \sum_{k=l+1}^{\infty} \lambda_k,$$

and if one intends to solve optimization problems, also ensure

$$\|p(t) - \sum_{k=1}^l (p(t), \chi_k)_V \chi_k\|_{W(0, T)}^2 \sim \sum_{k=l+1}^{\infty} \lambda_k,$$

## Conclusions from the analysis

- Get rid of  $\|(y - \mathcal{P}^\ell y)_t\|_{L^2(0, T; V')}$  → include derivative information into your snapshot set.
- Get rid of  $\|p - \mathcal{P}^\ell p\|_{W(0, T)}^2$  → include adjoint information into your snapshot set.

Recipe:

For  $l \in \mathbb{N}$  choose a POD subspace  $V^l := \langle \chi_1, \dots, \chi_l \rangle$  of  $V$  with the property

$$\|y(t) - \sum_{k=1}^l (y(t), \chi_k)_V \chi_k\|_{W(0, T)}^2 \sim \sum_{k=l+1}^{\infty} \lambda_k,$$

and if one intends to solve optimization problems, also ensure

$$\|p(t) - \sum_{k=1}^l (p(t), \chi_k)_V \chi_k\|_{W(0, T)}^2 \sim \sum_{k=l+1}^{\infty} \lambda_k,$$

## Error between state and its orthogonal projection

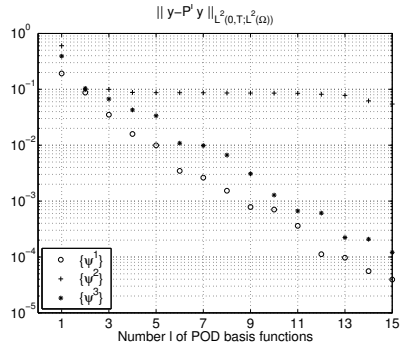
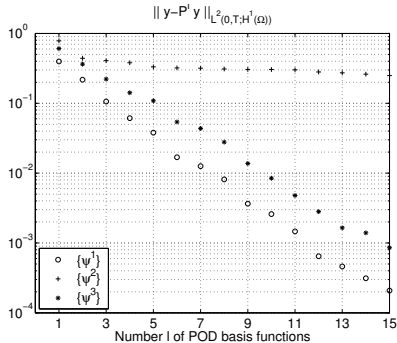

## Error between co-state and its orthogonal projection

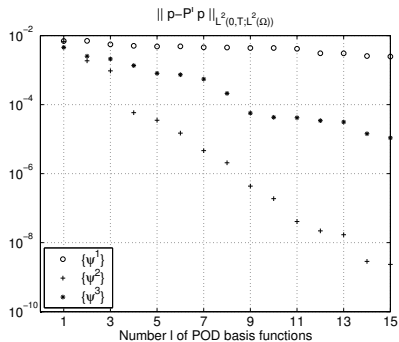
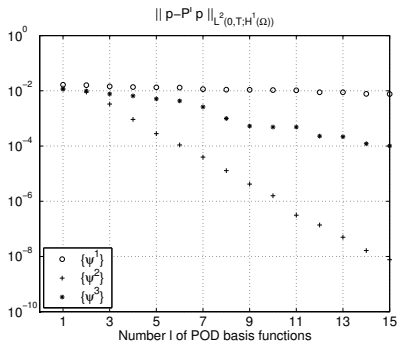

## Neumann boundary control of the heat equation

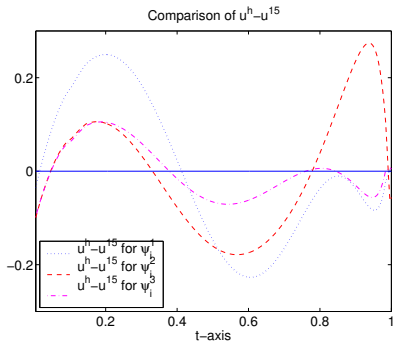
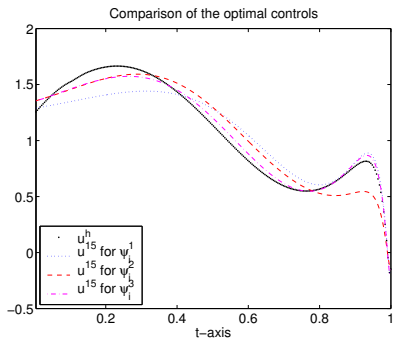

## Error in numbers

$\ell$	$\ u^h - u^\ell\ $ for $\{\psi_i^1\}_{i=1}^\ell$	$\ u^h - u^\ell\ $ for $\{\psi_i^2\}_{i=1}^\ell$	$\ u^h - u^\ell\ $ for $\{\psi_i^3\}_{i=1}^\ell$
$\ell = 1$	0.5100	0.5437	0.4672
$\ell = 3$	0.3792	0.1200	0.1869
$\ell = 5$	0.3506	0.0588	0.1201
$\ell = 7$	0.3225	0.0584	0.0676
$\ell = 9$	0.3031	0.0585	0.0566
$\ell = 11$	0.2902	0.0585	0.0557
$\ell = 13$	0.2057	0.0596	0.0555
$\ell = 15$	0.1530	0.1282	0.0555

Details & more results in H., Volkwein COAP 39(3), 2008.

# POD-MOR and adaptive concepts

- Spatial adaptivity** [Gräßle, H., 2017]

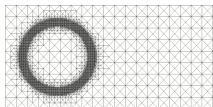
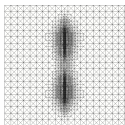

**Problem:** Snapshots are vectors of different lengths! → lecture 1.

- Time adaptivity (snapshot location)** [Alla, Gräßle, H., 2016]

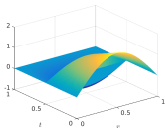

What are **suitable time instances** for the snapshots? → discussion now!

- POD basis updates for optimal control problems** [Gräßle, Gubisch, Metzdorf, Rogg, Volkwein, 2016; Alla, Gräßle, H., 2016]

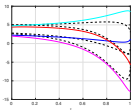

How to choose a **suitable input control** for snapshot generation? → discussion now!

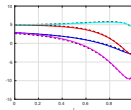

# POD-MOR and adaptive concepts

## • Spatial adaptivity [Gräßle, H., 2017]

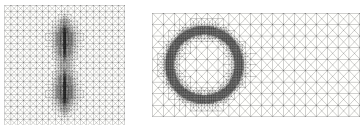

**Problem:** Snapshots are vectors of different lengths! → lecture 1.

## • Time adaptivity (snapshot location) [Alla, Gräßle, H., 2016]

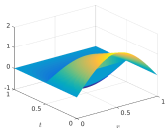

What are **suitable time instances** for the snapshots? → discussion now!

## • POD basis updates for optimal control problems [Gräßle, Gubisch, Metzdorf, Rogg, Volkwein, 2016; Alla, Gräßle, H., 2016]

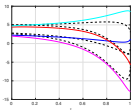

How to choose a **suitable input control** for snapshot generation? → discussion now!

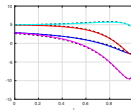



## POD-MOR and adaptive concepts

### • Spatial adaptivity [Gräßle, H., 2017]

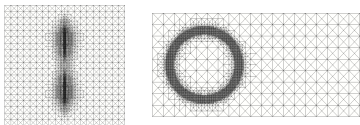

**Problem:** Snapshots are vectors of different lengths! → lecture 1.

### • Time adaptivity (snapshot location) [Alla, Gräßle, H., 2016]

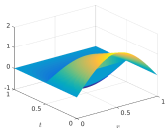

What are **suitable time instances** for the snapshots? → discussion now!

### • POD basis updates for optimal control problems [Gräßle, Gubisch, Metzdorf, Rogg, Volkwein, 2016; Alla, Gräßle, H., 2016]

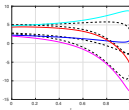

How to choose a **suitable input control** for snapshot generation? → discussion now!

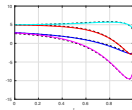

## POD-MOR and adaptive concepts

### • Spatial adaptivity [Gräßle, H., 2017]

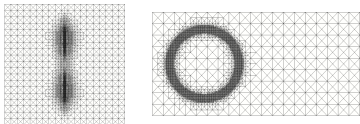

**Problem:** Snapshots are vectors of different lengths! → lecture 1.

### • Time adaptivity (snapshot location) [Alla, Gräßle, H., 2016]

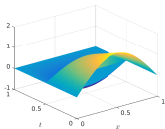

What are **suitable time instances** for the snapshots? → discussion now!

### • POD basis updates for optimal control problems [Gräßle, Gubisch, Metzdorf, Rogg, Volkwein, 2016; Alla, Gräßle, H., 2016]

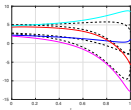

How to choose a **suitable input control** for snapshot generation? → discussion now!

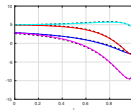

## POD-MOR and adaptive concepts

- Spatial adaptivity [Gräßle, H., 2017]

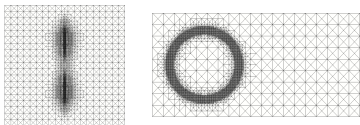

**Problem:** Snapshots are vectors of different lengths! → lecture 1.

- Time adaptivity (snapshot location) [Alla, Gräßle, H., 2016]

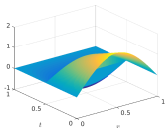

What are **suitable time instances** for the snapshots? → discussion now!

- POD basis updates for optimal control problems [Gräßle, Gubisch, Metzdorf, Rogg, Volkwein, 2016; Alla, Gräßle, H., 2016]

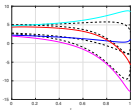

How to choose a **suitable input control** for snapshot generation? → discussion now!

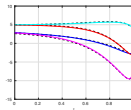

## Aim: POD model order reduction for optimal control problems

**Original problem:**

$$\min_{u \in \mathcal{U}_{\text{ad}}} \hat{J}(u) := J(y(u), u)$$



**POD-Galerkin approximation:**

$$\min_{u \in \mathcal{U}_{\text{ad}}} \hat{J}^\ell(u) := J(y^\ell(u), u)$$

### POD reduced order modelling:

- choose suitable snapshots, e.g.  $\mathcal{V} := \{y(t) \mid t \in [0, T]\}$  for an input control  $u$
- compute POD basis  $\{\psi_1, \dots, \psi_\ell\}$  of rank  $\ell$
- set up the Galerkin ansatz  $y^\ell(x, t) = \sum_{i=1}^{\ell} y_i(t) \psi_i(x)$ , non local basis
- surrogate model  $\rightarrow$  low dimension

## Motivation

POD basis  $\{\psi_1, \dots, \psi_\ell\}$   $\leftrightarrow$  snapshots  $\{y^N(t_0), \dots, y^N(t_n)\}$

**AIM: Snapshots with good quality: the snapshots should comply with the physical properties of the underlying system**

- **choose suitable time instances for the snapshots – snapshot locations**  
→ **generation of snapshots with time-adaptivity**
- **choose a suitable input control for snapshot generation**  
→ **compute an approximation of the optimal control**
- **cheap offline-phase for POD**  
→ **utilize a coarse spatial grid**

## Literature on snapshot location strategies

- K. Kunisch, S. Volkwein: **Proper Orthogonal Decomposition for optimality systems**, *ESAIM: Mathematical Modelling and Numerical Analysis*, 42:1-23, 2008
- K. Kunisch, S. Volkwein: **Optimal Snapshot Location for computing POD basis functions**, *ESAIM: Mathematical Modelling and Numerical Analysis*, 44:509-529, 2010
- R.H.W. Hoppe, Z. Liu: **Snapshot location by error equilibration in proper orthogonal decomposition for linear and semilinear parabolic partial differential equations**, *Journal of Numerical Mathematics*, 22:1-32, 2014
- A. Alla, C. Gräßle, M. Hinze: **A-posteriori snapshot location for POD in optimal control of linear parabolic equations**, *arXiv:1608.08665*

## Mother Problem setting

$$\min_{(y,u) \in \mathcal{Y} \times \mathcal{U}_{\text{ad}}} J(y, u) := \frac{1}{2} \|y - y_d\|_{L^2(\Omega_T)}^2 + \frac{\alpha}{2} \|u\|_{L^2(\Omega_T)}^2$$

s. t.

$$(SE) \quad \begin{cases} y_t(x, t) - \nu \Delta y(x, t) & = f(x, t) + (\mathcal{B}u)(x, t) & \text{in } \Omega_T \\ y(x, t) & = 0 & \text{on } \Sigma_T \\ y(x, 0) & = y_0(x) & \text{in } \Omega \end{cases}$$

and

$$u \in \mathcal{U}_{\text{ad}} := \{u \in L^2(0, T; \mathbb{R}^m) \mid u_a(t) \leq u(t) \leq u_b(t) \text{ f.a.a } t \in [0, T]\}$$

where  $\Omega \subset \mathbb{R}^n$  open bounded domain with smooth boundary,  $\Omega_T = \Omega \times (0, T]$ ,

$\Sigma_T = \partial\Omega \times (0, T]$ ,  $\alpha, \nu > 0$ ,  $y_d, f \in L^2(\Omega_T)$ ,  $y_0 \in H_0^1(\Omega)$ ,

$\mathcal{B} : L^2(0, T; \mathbb{R}^m) \rightarrow L^2(0, T; H^{-1}(\Omega))$  linear bounded operator,

$u_a, u_b \in L^\infty(0, T)$ ,  $\mathcal{Y} = W(0, T) = \{v \in L^2(0, T; H_0^1(\Omega)), v_t \in L^2(0, T; H^{-1}(\Omega))\}$

## Optimality system and discretization

### Optimality system

$$(SE) \quad \begin{cases} y_t - \nu \Delta y &= f + \mathcal{B}u \\ y &= 0 \\ y(\cdot, 0) &= y_0 \end{cases} \quad (AE) \quad \begin{cases} -p_t - \nu \Delta p &= y - y_d & \text{in } \Omega_T \\ p &= 0 & \text{on } \Sigma_T \\ p(\cdot, T) &= 0 & \text{in } \Omega \end{cases}$$

$$(VI) \quad \langle \alpha u + \mathcal{B}^* p, v - u \rangle_U \geq 0 \text{ for all } v \in U_{ad}$$

### Finite element discretization

$$\begin{aligned} M \dot{y}^N - \nu A y^N &= f^N + \mathcal{B}^N u, & y^N(0) &= y_0^N, \\ -M \dot{p}^N - \nu A p^N &= y^N - y_d^N, & p^N(T) &= 0, \\ \langle \alpha u + (\mathcal{B}^*)^N p^N, v - u \rangle_U &\geq 0. \end{aligned}$$



## Reformulation to an elliptic PDE

Optimality system:

$$\begin{cases} \text{(SE):} & y_t - \nu \Delta y = f + \mathcal{B}u & \text{in } \Omega_T, & y = 0 & \text{on } \Sigma_T, & y(0) = y_0 & \text{in } \Omega \\ \text{(AE):} & -p_t - \nu \Delta p = y - y_d & \text{in } \Omega_T, & p = 0 & \text{on } \Sigma_T, & p(T) = 0 & \text{in } \Omega \\ \text{(VI):} & \langle \alpha u + \mathcal{B}^* p, v - u \rangle_U \geq 0 & \text{for all } v \in U_{\text{ad}} \end{cases}$$

---

$$y_0 \in H_0^1(\Omega), y_d \in L^2(\Omega_T) \Rightarrow p \in H^{2,1}(\Omega_T) := L^2(0, T; H^2(\Omega) \cap H_0^1(\Omega)) \cap H^1(0, T; L^2(\Omega))$$

---

**Reformulation:** The optimal adjoint state  $p$  fulfills:  $(y_d \in H^{2,1}(\Omega_T))$

$$(ES_p) \begin{cases} -p_{tt} + \nu \Delta^2 p - \mathcal{B} \mathcal{P}_{U_{\text{ad}}} \left( -\frac{1}{\alpha} \mathcal{B}^* p \right) = -(y_d)_t + \Delta y_d & \text{in } \Omega_T \\ p = 0 & \text{on } \Sigma_T \\ \Delta p = y_d & \text{on } \Sigma_T \\ (p_t + \Delta p)(0) = y_d(0) - y_0 & \text{in } \Omega \\ p(T) = 0 & \text{in } \Omega \end{cases}$$

## Reformulation to an elliptic PDE

Optimality system:

$$\begin{cases} \text{(SE):} & y_t - \nu \Delta y = f + \mathcal{B}u & \text{in } \Omega_T, & y = 0 & \text{on } \Sigma_T, & y(0) = y_0 & \text{in } \Omega \\ \text{(AE):} & -p_t - \nu \Delta p = y - y_d & \text{in } \Omega_T, & p = 0 & \text{on } \Sigma_T, & p(T) = 0 & \text{in } \Omega \\ \text{(VI):} & \langle \alpha u + \mathcal{B}^* p, v - u \rangle_U \geq 0 & \text{for all } v \in U_{\text{ad}} \end{cases}$$

---

$$y_0 \in H_0^1(\Omega), y_d \in L^2(\Omega_T) \Rightarrow p \in H^{2,1}(\Omega_T) := L^2(0, T; H^2(\Omega) \cap H_0^1(\Omega)) \cap H^1(0, T; L^2(\Omega))$$

---

**Reformulation:** The optimal adjoint state  $p$  fulfills:  $(y_d \in H^{2,1}(\Omega_T))$

$$\text{(ES}_p\text{)} \left\{ \begin{array}{ll} -p_{tt} + \nu \Delta^2 p - \mathcal{B} \mathcal{P}_{U_{\text{ad}}} \left( -\frac{1}{\alpha} \mathcal{B}^* p \right) = -(y_d)_t + \Delta y_d & \text{in } \Omega_T \\ p = 0 & \text{on } \Sigma_T \\ \Delta p = y_d & \text{on } \Sigma_T \\ (p_t + \Delta p)(0) = y_d(0) - y_0 & \text{in } \Omega \\ p(T) = 0 & \text{in } \Omega \end{array} \right.$$

## Reformulation to an elliptic PDE

Optimality system:

$$\begin{cases} \text{(SE):} & y_t - \nu \Delta y = f + \mathcal{B}u & \text{in } \Omega_T, & y = 0 & \text{on } \Sigma_T, & y(0) = y_0 & \text{in } \Omega \\ \text{(AE):} & -p_t - \nu \Delta p = y - y_d & \text{in } \Omega_T, & p = 0 & \text{on } \Sigma_T, & p(T) = 0 & \text{in } \Omega \\ \text{(VI):} & \langle \alpha u + \mathcal{B}^* p, v - u \rangle_U \geq 0 & \text{for all } v \in U_{\text{ad}} \end{cases}$$

---

$$y_0 \in H_0^1(\Omega), y_d \in L^2(\Omega_T) \Rightarrow p \in H^{2,1}(\Omega_T) := L^2(0, T; H^2(\Omega) \cap H_0^1(\Omega)) \cap H^1(0, T; L^2(\Omega))$$

---

**Reformulation:** The optimal adjoint state  $p$  fulfills:  $(y_d \in H^{2,1}(\Omega_T))$

$$\text{(ES}_p\text{)} \left\{ \begin{array}{ll} -p_{tt} + \nu \Delta^2 p - \mathcal{B} \mathcal{P}_{U_{\text{ad}}} \left( -\frac{1}{\alpha} \mathcal{B}^* p \right) & = -(y_d)_t + \Delta y_d & \text{in } \Omega_T \\ p & = 0 & \text{on } \Sigma_T \\ \Delta p & = y_d & \text{on } \Sigma_T \\ (p_t + \Delta p)(0) & = y_d(0) - y_0 & \text{in } \Omega \\ p(T) & = 0 & \text{in } \Omega \end{array} \right.$$

## Temporal residual type a-posteriori error estimates<sup>[1]</sup>

**Time discretization:**  $0 = t_0 < \dots < t_n = T$ ,  $\Delta t_j = t_j - t_{j-1}$ ,  $I_j = [t_{j-1}, t_j]$   
 $V_t^k = \{v \in H^{2,1}(\Omega_T) : v(\cdot)|_{I_j} \in P_1(I_j)\}$ ,  $\bar{V}_t^k = V_t^k \cap H_0^{2,1}(\Omega_T)$

---

[1] following W. Gong, M. Hinze, Z. J. Zhou, Space-time finite element approximation of parabolic optimal control problems

## Temporal residual type a-posteriori error estimates<sup>[1]</sup>

**Time discretization:**  $0 = t_0 < \dots < t_n = T$ ,  $\Delta t_j = t_j - t_{j-1}$ ,  $I_j = [t_{j-1}, t_j]$   
 $V_t^k = \{v \in H^{2,1}(\Omega_T) : v(\cdot)|_{I_j} \in P_1(I_j)\}$ ,  $\bar{V}_t^k = V_t^k \cap H_0^{2,1}(\Omega_T)$   
 For  $p \in H_0^{2,1}$  and the time-discrete approximation  $p_k \in \bar{V}_t^k$  we have:

$$(*) \quad \| p - p_k \|_{H^{2,1}(\Omega_T)}^2 \leq C \cdot \eta_p^2$$

where

$$\eta_p^2 = \sum_j \Delta t_j^2 \int_{I_j} \| -(y_d)_t + \Delta y_d + (p_k)_{tt} - \mathcal{B}\mathcal{P}U_{ad} \left( -\frac{1}{\alpha} \mathcal{B}^* p_k \right) - \Delta^2 p_k \|^2_{L^2(\Omega)} \\ + \sum_j \int_{I_j} \| y_d - \Delta p_k \|^2_{L^2(\Gamma)}$$

[1] following W. Gong, M. Hinze, Z. J. Zhou, Space-time finite element approximation of parabolic optimal control problems

## Temporal residual type a-posteriori error estimates<sup>[1]</sup>

**Time discretization:**  $0 = t_0 < \dots < t_n = T$ ,  $\Delta t_j = t_j - t_{j-1}$ ,  $I_j = [t_{j-1}, t_j]$

$V_t^k = \{v \in H^{2,1}(\Omega_T) : v(\cdot)|_{I_j} \in P_1(I_j)\}$ ,  $\bar{V}_t^k = V_t^k \cap H_0^{2,1}(\Omega_T)$

For  $p \in H_0^{2,1}$  and the time-discrete approximation  $p_k \in \bar{V}_t^k$  we have:

$$(*) \quad \|p - p_k\|_{H^{2,1}(\Omega_T)}^2 \leq C \cdot \eta_p^2$$

where

$$\begin{aligned} \eta_p^2 = & \sum_j \Delta t_j^2 \int_{I_j} \| -(y_d)_t + \Delta y_d + (p_k)_{tt} - \mathcal{B}\mathcal{P}U_{\text{ad}} \left( -\frac{1}{\alpha} \mathcal{B}^* p_k \right) - \Delta^2 p_k \|^2_{L^2(\Omega)} \\ & + \sum_j \int_{I_j} \| y_d - \Delta p_k \|^2_{L^2(\Gamma)} \end{aligned}$$

Similarly

$$(\diamond) \quad \|y - y_k\|_{H^{2,1}(\Omega_T)}^2 \leq C \cdot \eta_y^2$$

[1] following W. Gong, M. Hinze, Z. J. Zhou, Space-time finite element approximation of parabolic optimal control problems

## Temporal residual type a-posteriori error estimates<sup>[1]</sup>

**Time discretization:**  $0 = t_0 < \dots < t_n = T$ ,  $\Delta t_j = t_j - t_{j-1}$ ,  $I_j = [t_{j-1}, t_j]$   
 $V_t^k = \{v \in H^{2,1}(\Omega_T) : v(\cdot)|_{I_j} \in P_1(I_j)\}$ ,  $\bar{V}_t^k = V_t^k \cap H_0^{2,1}(\Omega_T)$   
 For  $p \in H_0^{2,1}$  and the time-discrete approximation  $p_k \in \bar{V}_t^k$  we have:

$$(\star) \quad \|p - p_k\|_{H^{2,1}(\Omega_T)}^2 \leq C \cdot \eta_p^2$$

where

$$\eta_p^2 = \sum_j \Delta t_j^2 \int_{I_j} \| -(y_d)_t + \Delta y_d + (p_k)_{tt} - \mathcal{B}\mathcal{P}U_{\text{ad}} \left( -\frac{1}{\alpha} \mathcal{B}^* p_k \right) - \Delta^2 p_k \|^2_{L^2(\Omega)} \\ + \sum_j \int_{I_j} \| y_d - \Delta p_k \|^2_{L^2(\Gamma)}$$

Similarly

$$(\diamond) \quad \|y - y_k\|_{H^{2,1}(\Omega_T)}^2 \leq C \cdot \eta_y^2$$

**Idea:** go for an adaptive time grid utilizing  $(\star)$ ,  $(\diamond)$  based on a coarse spatial resolution. At the same time get an approximation of the optimal control. Use this control for snapshot generation.

[1] following W. Gong, M. Hinze, Z. J. Zhou, Space-time finite element approximation of parabolic optimal control problems

## A-posteriori snapshot location Strategie

---

**Algorithm 1:** Adaptive snapshot location for optimal control problems.

---

$\Delta x$  coarse,  $h$  spatial grid size.

- Solve  $(ES_p)$  and/or  $(ES_y)$  adaptively w.r.t. time with spatial resolution  $\Delta x$ .  
→ Obtain time grid  $\mathcal{T}$  + approximation of the optimal adjoint state  $p_{\Delta x}$
  - Compute  $u_{\Delta x} = \mathcal{P}_{U_{ad}} \left( -\frac{1}{\alpha} \mathcal{B}^* p_{\Delta x} \right)$ .
  - Use this control  $u_{\Delta x}$  to generate snapshots on the time grid  $\mathcal{T}$  by a full simulation with spatial resolution  $h$ .
  - Compute a POD basis of order  $\ell$  and build the POD-ROM.
  - Solve the POD-ROM on the time adaptive grid  $\mathcal{T}$ .
-



## A-posteriori snapshot location Strategie

---

**Algorithm 1:** Adaptive snapshot location for optimal control problems.

---

$\Delta x$  coarse,  $h$  spatial grid size.

- Solve  $(ES_p)$  and/or  $(ES_y)$  adaptively w.r.t. time with spatial resolution  $\Delta x$ .  
→ Obtain time grid  $\mathcal{T}$  + approximation of the optimal adjoint state  $p_{\Delta x}$
  - Compute  $u_{\Delta x} = \mathcal{P}_{U_{ad}} \left( -\frac{1}{\alpha} \mathcal{B}^* p_{\Delta x} \right)$ .
  - Use this control  $u_{\Delta x}$  to generate snapshots on the time grid  $\mathcal{T}$  by a full simulation with spatial resolution  $h$ .
  - Compute a POD basis of order  $\ell$  and build the POD-ROM.
  - Solve the POD-ROM on the time adaptive grid  $\mathcal{T}$ .
- 

- Embed this strategy (e.g. as initialization step) into POD-MOR algorithms for optimal control problems, like TRPOD (Fahl & Sachs), APOD (Afansiev & Hinze), OSPOD (Kunisch & Volkwein).
- For nonlinear problems use this method for the Newton system.

## Error estimation

For the error in the optimal control we have ( $k$  discrete time,  $l$  POD parameter)

$$\|u - u_k^l\| + \|y - y_k^l\| \sim \|p(u) - \tilde{p}_k^l(u)\| + \|y(u) - \tilde{y}_k^l(u)\|.$$

Here,  $\tilde{y}_k^l(u)$  denotes the POD approximation to  $y(u)$ , and  $\tilde{p}_k^l(u)$  the POD approximation to  $p(u)$ .

Now

$$\|p(u) - \tilde{p}_k^l(u)\| \sim \underbrace{\|p(u) - p_k(u)\|}_{\sim \eta_p} + \underbrace{\|p_k(u) - \tilde{p}_k^l(u)\|}_{\sim \sum_{i \geq l} \lambda_i},$$

and

$$\|y(u) - \tilde{y}_k^l(u)\| \sim \underbrace{\|y(u) - y_k(u)\|}_{\sim \eta_y} + \underbrace{\|y_k(u) - \tilde{y}_k^l(u)\|}_{\sim \sum_{i \geq l} \lambda_i}.$$

Thus

$$\|u - u_k^l\| + \|y - y_k^l\| \sim \eta_p + \eta_y + \sim \sum_{i \geq l} \lambda_i.$$

## Numerical Test Example

$$(P) \min_{(y,u) \in \mathcal{Y} \times \mathcal{U}} J(y,u) := \frac{1}{2} \|y - y_d\|_{L^2(\Omega_T)}^2 + \frac{\alpha}{2} \|u\|_{\mathcal{U}}^2$$

s.t.

$$(SE) \begin{cases} y_t - \Delta y &= \sum_{i=1}^2 u_i \chi_i + f & \text{in } \Omega_T \\ y &= 0 & \text{on } \Sigma_T \\ y(0) &= y_0 & \text{in } \Omega \end{cases}$$

$$u \in \mathcal{U} = L^2(0, T; \mathbb{R}^m)$$

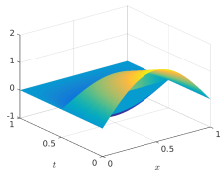

$$p_{ex} = \sin(\pi x) \operatorname{atan}\left(\frac{t-0.5}{\varepsilon}\right)(t-1)$$

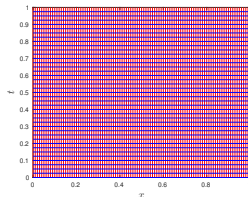
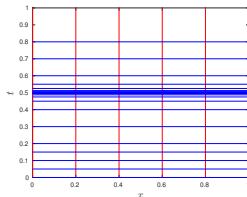
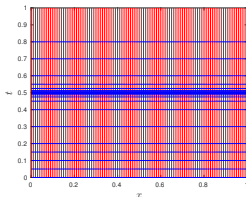

adaptive space-time grids with dof=21 and  $\Delta x = 1/100$  (left),  $\Delta x = 1/5$  (middle), euidistant (right)

## Numerical Test Example

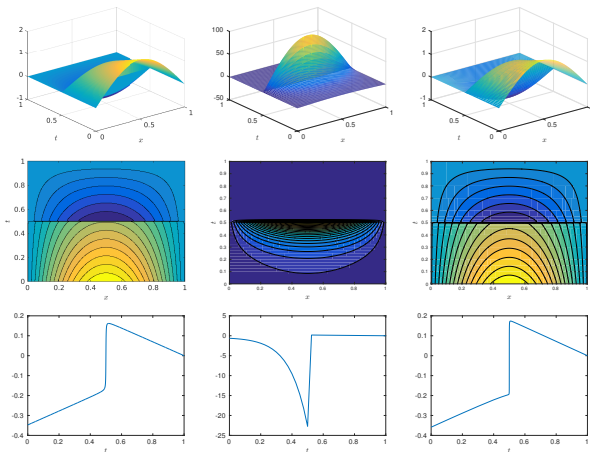

adjoint state and control (left), POD solution: equidistant grid  $\Delta t = 1/40$  (middle), adaptive grid dof=41 (right)

## Numerical Test Example

$\Delta t$	$\epsilon_{\text{abs}}^y$	$\epsilon_{\text{abs}}^u$	$\epsilon_{\text{abs}}^p$
1/20	$5.07 \cdot 10^{-01}$	$7.84 \cdot 10^{+00}$	$3.54 \cdot 10^{+01}$
1/40	$2.62 \cdot 10^{-01}$	$4.10 \cdot 10^{+00}$	$1.85 \cdot 10^{+01}$
1/68	$1.56 \cdot 10^{-01}$	$2.45 \cdot 10^{+00}$	$1.10 \cdot 10^{+01}$
1/134	$7.87 \cdot 10^{-02}$	$1.23 \cdot 10^{+00}$	$5.59 \cdot 10^{+00}$

dof	$\epsilon_{\text{abs}}^y$	$\epsilon_{\text{abs}}^u$	$\epsilon_{\text{abs}}^p$
21	$4.03 \cdot 10^{-02}$	$5.40 \cdot 10^{-01}$	$2.44 \cdot 10^{+00}$
41	$2.22 \cdot 10^{-04}$	$5.34 \cdot 10^{-03}$	$1.31 \cdot 10^{-02}$
69	$9.76 \cdot 10^{-05}$	$4.57 \cdot 10^{-03}$	$4.26 \cdot 10^{-03}$
135	$8.64 \cdot 10^{-05}$	$4.49 \cdot 10^{-03}$	$2.35 \cdot 10^{-03}$

**Table:** approximation quality: error in POD solution compared to the analytical solution on the uniform time grid (top) and the adaptive time grid (bottom),  $\ell = 5$

## Numerical Test Example

$\Delta t$	$\epsilon_{\text{abs}}^y$	$\epsilon_{\text{abs}}^u$	$\epsilon_{\text{abs}}^p$	$J(y^\ell, u)$
1/20	$5.07 \cdot 10^{-01}$	$7.84 \cdot 10^{+00}$	$3.54 \cdot 10^{+01}$	$3.12 \cdot 10^{+05}$
1/40	$2.62 \cdot 10^{-01}$	$4.10 \cdot 10^{+00}$	$1.85 \cdot 10^{+01}$	$1.56 \cdot 10^{+05}$
1/68	$1.56 \cdot 10^{-01}$	$2.45 \cdot 10^{+00}$	$1.10 \cdot 10^{+01}$	$9.19 \cdot 10^{+04}$
1/134	$7.87 \cdot 10^{-02}$	$1.23 \cdot 10^{+00}$	$5.59 \cdot 10^{+00}$	$4.66 \cdot 10^{+04}$

dof	$\epsilon_{\text{abs}}^y$	$\epsilon_{\text{abs}}^u$	$\epsilon_{\text{abs}}^p$	$J(y^\ell, u)$
21	$4.03 \cdot 10^{-02}$	$5.40 \cdot 10^{-01}$	$2.44 \cdot 10^{+00}$	$1.95 \cdot 10^{+04}$
41	$2.22 \cdot 10^{-04}$	$5.34 \cdot 10^{-03}$	$1.31 \cdot 10^{-02}$	$1.02 \cdot 10^{+03}$
69	$9.76 \cdot 10^{-05}$	$4.57 \cdot 10^{-03}$	$4.26 \cdot 10^{-03}$	$1.00 \cdot 10^{+03}$
135	$8.64 \cdot 10^{-05}$	$4.49 \cdot 10^{-03}$	$2.35 \cdot 10^{-03}$	$1.00 \cdot 10^{+03}$

**Table:** approximation quality: error in POD solution compared to the analytical solution on the uniform time grid (top) and the adaptive time grid (bottom),  $\ell = 5$ , analytical value  $J \approx 1.0085 \cdot 10^{+03}$

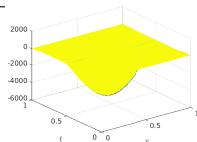
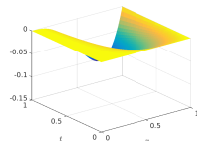

**Figure:** true and desired state

## Numerical Test Example

$\Delta t$	$\epsilon_{\text{abs}}^y$	$\epsilon_{\text{abs}}^u$	$\epsilon_{\text{abs}}^p$	$J(y^\ell, u)$
1/20	$5.07 \cdot 10^{-01}$	$7.84 \cdot 10^{+00}$	$3.54 \cdot 10^{+01}$	$3.12 \cdot 10^{+05}$
1/40	$2.62 \cdot 10^{-01}$	$4.10 \cdot 10^{+00}$	$1.85 \cdot 10^{+01}$	$1.56 \cdot 10^{+05}$
1/68	$1.56 \cdot 10^{-01}$	$2.45 \cdot 10^{+00}$	$1.10 \cdot 10^{+01}$	$9.19 \cdot 10^{+04}$
1/134	$7.87 \cdot 10^{-02}$	$1.23 \cdot 10^{+00}$	$5.59 \cdot 10^{+00}$	$4.66 \cdot 10^{+04}$

dof	$\epsilon_{\text{abs}}^y$	$\epsilon_{\text{abs}}^u$	$\epsilon_{\text{abs}}^p$	$J(y^\ell, u)$
21	$4.03 \cdot 10^{-02}$	$5.40 \cdot 10^{-01}$	$2.44 \cdot 10^{+00}$	$1.95 \cdot 10^{+04}$
41	$2.22 \cdot 10^{-04}$	$5.34 \cdot 10^{-03}$	$1.31 \cdot 10^{-02}$	$1.02 \cdot 10^{+03}$
69	$9.76 \cdot 10^{-05}$	$4.57 \cdot 10^{-03}$	$4.26 \cdot 10^{-03}$	$1.00 \cdot 10^{+03}$
135	$8.64 \cdot 10^{-05}$	$4.49 \cdot 10^{-03}$	$2.35 \cdot 10^{-03}$	$1.00 \cdot 10^{+03}$

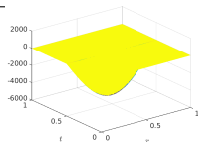
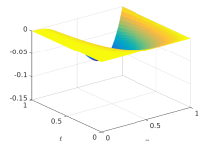

Figure: true and desired state

Table: approximation quality: error in POD solution compared to the analytical solution on the uniform time grid (top) and the adaptive time grid (bottom),  $\ell = 5$ , analytical value  $J \approx 1.0085 \cdot 10^{+03}$

$$\|p(u) - p_k^\ell(u_k^\ell)\| \leq \underbrace{\|p(u) - p_k(u)\|}_{\sim \eta_p \in [0.1, 1]} + \underbrace{\|p_k(u) - p_k^\ell(u)\|}_{\sim \sum_{i=\ell+1}^n \lambda_i \approx 10^{-15}}$$

## Numerical Test Example

Include **control constraints**:  $u_a = \begin{pmatrix} -100 \\ -0.2 \end{pmatrix}$  and  $u_b = \begin{pmatrix} 0.1 \\ 0 \end{pmatrix}$ .

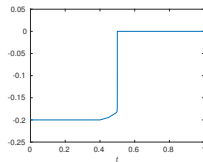
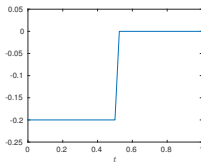
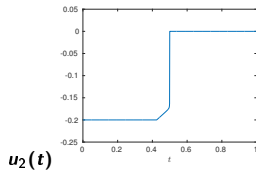
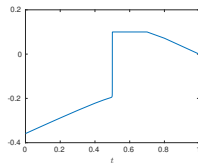
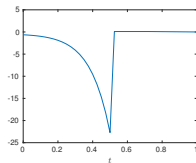
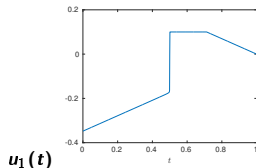

box constraints:  $\bar{u}_1(t)$  (top left) and  $\bar{u}_2(t)$  (bottom left), POD control equidistant (middle), adaptive (right)



## Numerical Test Example

Include **control constraints**:

$\Delta t$	$\varepsilon_{\text{abs}}^y$	$\varepsilon_{\text{abs}}^u$	$\varepsilon_{\text{abs}}^p$
1/20	$2.86 \cdot 10^{-01}$	$5.72 \cdot 10^{+00}$	$3.54 \cdot 10^{+01}$
1/40	$1.48 \cdot 10^{-01}$	$2.99 \cdot 10^{+00}$	$1.85 \cdot 10^{+01}$
1/68	$8.81 \cdot 10^{-02}$	$1.78 \cdot 10^{+00}$	$1.10 \cdot 10^{+01}$
1/134	$4.45 \cdot 10^{-02}$	$9.04 \cdot 10^{-01}$	$5.59 \cdot 10^{+00}$

dof	$\varepsilon_{\text{abs}}^y$	$\varepsilon_{\text{abs}}^u$	$\varepsilon_{\text{abs}}^p$
21	$2.27 \cdot 10^{-02}$	$3.95 \cdot 10^{-01}$	$2.44 \cdot 10^{+00}$
41	$2.94 \cdot 10^{-04}$	$4.49 \cdot 10^{-03}$	$1.31 \cdot 10^{-02}$
69	$2.12 \cdot 10^{-04}$	$3.28 \cdot 10^{-03}$	$4.26 \cdot 10^{-03}$
135	$2.13 \cdot 10^{-04}$	$3.13 \cdot 10^{-03}$	$2.34 \cdot 10^{-03}$

**Table:** approximation quality: error in POD solution compared to the analytical solution on the uniform time grid (top) and the adaptive time grid (bottom),  $\ell = 5$

## Alternatives

How many snapshots? and where to take them?

- i) How many snapshots?  $\rightarrow$  iterative goal oriented procedure.
- Goal: Resolve  $J(y)$
  - Start on coarse equi-distant time grid and compute snapshots
  - Build POD model and compute  $y_h$  and adjoint  $z_h$  of reduced dynamics
  - Becker and Rannacher:  $J(y) - J(y_h) \approx \eta(y_h, z_h)$
  - $\eta(y_h, z_h) > \text{tol}$ : double number of snapshots (re-computation)

## Alternatives

How many snapshots? and where to take them?

- i) How many snapshots?  $\rightarrow$  iterative goal oriented procedure.
  - Goal: Resolve  $J(y)$
  - Start on coarse equi-distant time grid and compute snapshots
  - Build POD model and compute  $y_h$  and adjoint  $z_h$  of reduced dynamics
  - Becker and Rannacher:  $J(y) - J(y_h) \approx \eta(y_h, z_h)$
  - $\eta(y_h, z_h) > \text{tol}$ : double number of snapshots (re-computation)
  
- ii) Where to take snapshots?  $\rightarrow$  time-step adaption via sensitivity of POD model.
  - Goal: Optimal time-grid for system dynamics
  - Start on coarse (equi-distant) time grid and compute snapshots
  - Build POD model and compute  $y_h$  and adjoint  $z_h$  of reduced dynamics
  - Becker, Johnson, Rannacher:  $\eta(y_h, z_h) = \sum_j \rho_j^{loc}(y_h) \omega_j^{loc}(z_h)$
  
  - New time-grid: equi-distribute  $\rho_j^{loc}(y_h) \omega_j^{loc}(z_h)$

## Conclusion

- **snapshot location** is important for a good approximation quality of the POD model
- generation of snapshots with **time adaptivity** produces improvement in POD solution and the approximation quality can be controlled by a-posteriori estimates
- in order to get good approximation results for both state and adjoint state a **post-processing** of the adaptive time grid for the snapshots might be necessary.

### Next steps

- Include **spatial adaptivity** in **adaptive** snapshot sampling.
- Integrate concept into optimization loop for problems with nonlinear PDE constraints.

## Conclusion

- **snapshot location** is important for a good approximation quality of the POD model
- generation of snapshots with **time adaptivity** produces improvement in POD solution and the approximation quality can be controlled by a-posteriori estimates
- in order to get good approximation results for both state and adjoint state a **post-processing** of the adaptive time grid for the snapshots might be necessary.

### Next steps

- Include **spatial adaptivity** in **adaptive** snapshot sampling.
- Integrate concept into optimization loop for problems with nonlinear PDE constraints.

## Conclusion

- **snapshot location** is important for a good approximation quality of the POD model
- generation of snapshots with **time adaptivity** produces improvement in POD solution and the approximation quality can be controlled by a-posteriori estimates
- in order to get good approximation results for both state and adjoint state a **post-processing** of the adaptive time grid for the snapshots might be necessary.

### Next steps

- Include **spatial adaptivity** in **adaptive** snapshot sampling.
- Integrate concept into optimization loop for problems with nonlinear PDE constraints.

## Recent developments–TRPOD by Arian, Fahl and Sachs 2000–

Idea: Use a POD surrogate model as model function in the Trust–Region process. Let

$$J(u) = J(y(u), u), \quad \hat{J}(u) = J(\hat{y}(u), u),$$

with  $\hat{y}(u)$  the response of the POD surrogate model.

Pseudo Algorithm:

- 1 Given  $u$ , compute POD model
- 2 Compute  $s^* = \operatorname{argmin}_{\|u-s\| \leq \Delta} \hat{J}(u+s)$
- 3

$$\rho := \frac{J(u+s^*) - J(u)}{\hat{J}(u+s^*) - \hat{J}(u)} \quad \left\{ \begin{array}{ll} \text{large:} & u = u + s^*, \quad \text{increase } \Delta \\ \text{moderate:} & u = u + s^*, \quad \text{decrease } \Delta \\ \text{small:} & \text{keep } u, \quad \text{decrease } \Delta \end{array} \right.$$

Global convergence under standard TR assumptions plus  $\frac{\|J'(u) - \hat{J}'(u)\|}{\|\hat{J}'(u)\|}$  sufficiently small.

## Recent developments—OSPOD by Kunisch and Volkwein 2006

Idea: Include choice of trajectory dependent POD modes as subsidiary condition into the optimization problem. This reads

$$(P'_{OSPOD}) \quad \begin{cases} \min_{\alpha, \Phi, u} \hat{J}(\alpha, \Phi, u) \text{ s.t.} \\ M(\Phi)\dot{\alpha} + A(\Phi)\alpha + n(\Phi)(\alpha) = B(\Phi)u, \\ M(\Phi)\alpha(0) = \alpha_0(\Phi), \\ y_t + \mathcal{A}y + \mathcal{G}(y) = \mathcal{B}u, \\ y(0) = y_0, \\ \mathcal{R}(y)\Phi_i = \lambda_i\Phi_i \text{ for } i = 1, \dots, l, \\ \|\Phi_i\|_X = 1 \text{ for } i = 1, \dots, l. \end{cases}$$

Here  $\Phi = [\Phi_1, \dots, \Phi_l]$ ,  $y^l = \sum_{i=1}^l \alpha_i(t)\Phi$ , and

$$\mathcal{R}(y)(z) := \int_0^T \langle y(t), z \rangle_X y(t) dt \text{ for } z \in X.$$

A very similar approach is proposed by Ghattas, van Bloemen Waanders and Willcox 2005.



## Further developments and improvements

- **Efficient treatment of nonlinearities** → Chaturantabut, Sorensen (2010)
- **MOR for the input–output map** → Heiland, Mehrmann
- **A posteriori POD concept** → Tröltzsch and Volkwein (2010)
- **Which modes?** → DWR concepts (Matthies, Meyer 2003)
- **How many snapshots?** → iterative goal oriented DWR procedure
- **Where to take snapshots?** → time–step adaption via sensitivity of the POD model
- **POD in the context of space–mapping** → talk Pinnau.
- **Sampling of parameter ( $\equiv$  control) space** → Greedy sampling by Patera and Rozza (2007)
- **Use of *linear* MOR techniques for nonlinear problems** → SQP context, semi–linear time integration, domain decomposition

Thank you for your attention

## Further developments and improvements

- **Efficient treatment of nonlinearities** → Chaturantabut, Sorensen (2010)
- **MOR for the input–output map** → Heiland, Mehrmann
- **A posteriori POD concept** → Tröltzsch and Volkwein (2010)
- **Which modes?** → DWR concepts (Matthies, Meyer 2003)
- **How many snapshots?** → iterative goal oriented DWR procedure
- **Where to take snapshots?** → time–step adaption via sensitivity of the POD model
- **POD in the context of space–mapping** → talk Pinnau.
- **Sampling of parameter ( $\equiv$  control) space** → Greedy sampling by Patera and Rozza (2007)
- **Use of *linear* MOR techniques for nonlinear problems** → SQP context, semi–linear time integration, domain decomposition

Thank you for your attention

# Towards POD-MOR for nonlinear PDE systems in networks

## Lecture 3

Proper Orthogonal Decomposition  
Mathematics & practical aspects  
Towards parametric model order reduction for nonlinear  
PDE systems in networks  
MOR Symposium Durham

Michael Hinze   Martin Kunkel   Ulrich Matthes   Morten Vierling  
Andreas Steinbrecher   Tatjana Stykel

Fachbereich Mathematik  
Universität Hamburg  
Michael.Hinze@uni-hamburg.de

August 10, 2017

## Outline

Motivation

PDAE-model

Finite Element Method

Simulation results

Construction of the reduced model

Location dependence of reduced model

Residual based parameter sampling

PABTEC and POD, joint work with A. Steinbrecher & Tatjana Stykel

## Sketch: network with complex and simple components

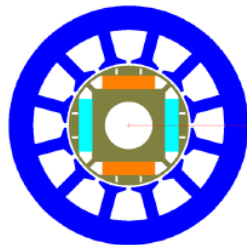
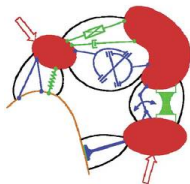
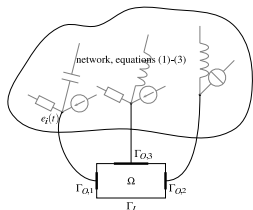

L: EN (MoreSim4Nano), M: MBS (courtesy BMBF SOFA), R: PSM (BMBF SIMUROM)

### Modeling

- ▶ *PDAE system*

### Aim

- ▶ Accurate reduced order models for complex components in networks
- ▶ Validity over relevant parameter range
- ▶ Accurate and robust *physical* reduced order model of the coupled system

## Motivation: Coupled circuit and semiconductor models

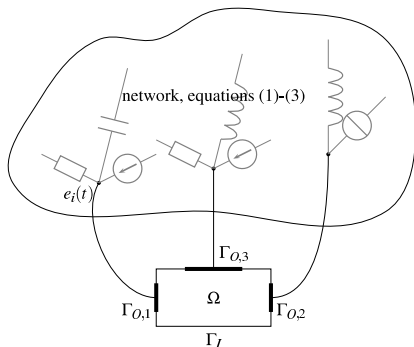

### Aim

- ▶ Accurate reduced order models for semiconductors in networks
- ▶ Validity over relevant parameter range
- ▶ Accurate *physical* reduced order model of the coupled system

# Outline

Motivation

PDAE-model

Finite Element Method

Simulation results

Construction of the reduced model

Location dependence of reduced model

Residual based parameter sampling

PABTEC and POD, joint work with A. Steinbrecher & Tatjana Stykel



# Coupled circuit and semiconductor models [M. Günther '01, C. Tischendorf '03]

Kirchhoff's' laws (no semiconductors) read

$$A_j = 0, \quad v = A^T e$$

$A$ : incidence matrix.

Voltage-current relations of components:

$$j_C = \frac{dq_C}{dt}(v_C, t), \quad j_R = g(v_R, t), \quad v_L = \frac{d\phi_L}{dt}(j_L, t)$$

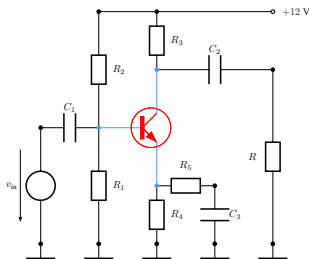

Modified Nodal Analysis: join all equations to DAE system

$$A_C \frac{dq_C}{dt} (A_C^T e(t), t) + A_R g (A_R^T e(t), t) + A_L j_L(t) + A_V j_V(t) = -A_I i_s(t),$$

$$\frac{d\phi_L}{dt} (j_L(t), t) - A_L^T e(t) = 0,$$

$$A_V^T e(t) = v_s(t).$$

## Coupled circuit and semiconductor models [M. Günther '01, C. Tischendorf '03]

How can semiconductors be introduced?

- ▶ replace semiconductor by a (possibly nonlinear) electrical network,
- ▶ stamp semiconductor network into surrounding network,
- ▶ apply Modified Nodal Analysis.
- ▶ Here: use PDE model for semiconductors  $\rightarrow$  DD equations.

## Coupled circuit and semiconductor models [M. Günther '01, C. Tischendorf '03]

PDE-model (drift-diffusion equations) for semiconductors

$$\begin{aligned} \operatorname{div}(\varepsilon \nabla \psi) &= q(n - p - C), \\ -q \partial_t n + \operatorname{div} J_n &= qR(n, p), \\ q \partial_t p + \operatorname{div} J_p &= -qR(n, p), \\ J_n &= \mu_n q (-U_T \nabla n - n \nabla \psi), \\ J_p &= \mu_p q (-U_T \nabla p - p \nabla \psi), \end{aligned}$$

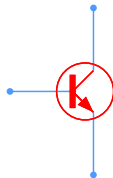

on  $\Omega \times [0, T]$  with  $\Omega \subset \mathbb{R}^d$  ( $d = 1, 2, 3$ ).

Dirichlet boundary constraints at  $\Gamma_{O,k}$ :

$$\psi(t, x) = \text{next slide}, \quad n(t, x) = \tilde{n}(x), \quad p(t, x) = \tilde{p}(x)$$

and Neumann boundary constraints at  $\Gamma_I$ :

$$\nabla \psi(t, x) \cdot \nu(x) = J_n \cdot \nu(x) = J_p(t, x) \cdot \nu(x) = 0$$

or mixed boundary conditions at MI contacts (MOSFETs).

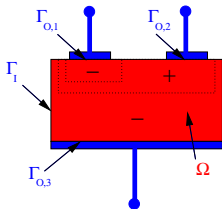

## Couple semiconductor to circuit [M. Günther '01, C. Tischendorf '03]

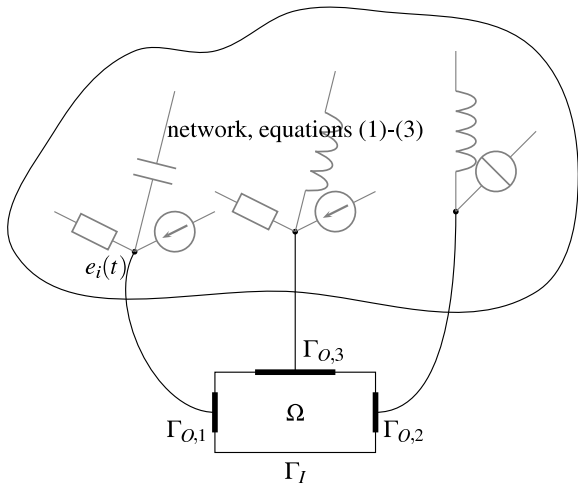

## Couple semiconductor to circuit [M. Günther '01, C. Tischendorf '03]

Coupling conditions:

$$j_{S,k}(t) = \int_{\Gamma_{O,k}} (J_n + J_p - \varepsilon \partial_t \nabla \psi) \cdot \nu \, d\sigma,$$

$$\psi(t, x) = \psi_{bi}(x) + (A_S^T e(t))_k$$

for  $(t, x) \in [0, T] \times \Gamma_{O,k}$ ,

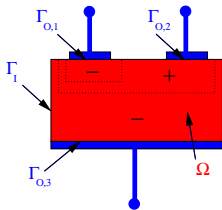

and add current  $j_S$  to Kirchhoff's current law:

$$A_C \frac{dq_C}{dt} (A_C^T e, t) + A_{RG} (A_R^T e, t) + A_L j_L + A_V j_V + A_S j_S = -A_I i_S,$$

$$\frac{d\phi_L}{dt} (j_L, t) - A_L^T e = 0,$$

$$A_V^T e = v_S.$$

Add DD-equations + coupling conditions for each semiconductor.

# Outline

Motivation

PDAE-model

**Finite Element Method**

Simulation results

Construction of the reduced model

Location dependence of reduced model

Residual based parameter sampling

PABTEC and POD, joint work with A. Steinbrecher & Tatjana Stykel

## Mixed formulation

The electric field  $E = -\nabla\psi$  plays dominant role in DD-equations.

### Mixed formulation

[Brezzi et al. '05]

Provide additional variable  $g_\psi$  and equation

$$g_\psi = \nabla\psi.$$

Scaled DD equations then read:

$$\begin{aligned} \lambda \operatorname{div} g_\psi &= n - p - C, \\ -\partial_t n + \nu_n \operatorname{div} J_n &= R(n, p), \\ \partial_t p + \nu_p \operatorname{div} J_p &= -R(n, p), \\ g_\psi &= \nabla\psi, \\ J_n &= \nabla n - n g_\psi, \\ J_p &= -\nabla p - p g_\psi. \end{aligned}$$

# Finite Element approximation

## Finite elements

- ▶ piecewise constant ansatz functions for  $\psi$ ,  $n$  and  $p$ .  
Basis functions:  $\varphi_i$ ,  $i = 1, \dots, N$ ,  $N = |\mathcal{T}|$ .
- ▶ Raviart-Thomas elements for  $g_\psi$ ,  $J_n$  and  $J_p$ .  
Basis functions:  $\phi_j$ ,  $i = 1, \dots, M$ ,  $M = |\mathcal{E}| - |\mathcal{E}_N|$ .

$$RT_0 := \{y : \Omega \rightarrow \mathbb{R}^d : y|_T(x) = a_T + b_T x, a_T \in \mathbb{R}^d, b_T \in \mathbb{R}, [y]_E \cdot \nu_E = 0, \text{ for all inner edges } E\}.$$

Galerkin ansatz:

$$\psi^h(t, x) = \sum_{i=1}^N \psi_i(t) \varphi_i(x), \quad g_\psi^h(t, x) = \sum_{j=1}^M g_{\psi,j}(t) \phi_j(x),$$

and analogously for  $n$ ,  $p$ ,  $J_n$ , and  $J_p$ .



# Full model

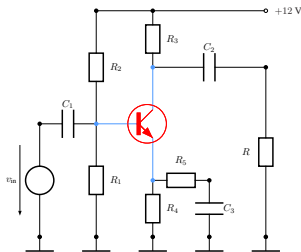

$$\begin{aligned}
 A_C \frac{dq_C}{dt} (A_C^T e(t), t) + A_{RG} (A_R^T e(t), t) \\
 + A_{Lj_L}(t) + A_{Vj_V}(t) + A_S j_S(t) = -A_I i_S(t), \\
 \frac{d\phi_L}{dt} (j_L(t), t) - A_L^T e(t) = 0, \\
 A_V^T e(t) = v_S(t),
 \end{aligned}$$

$$j_S(t) - C_1 j_n(t) - C_2 j_p(t) - C_3 \dot{g}_\psi(t) = 0,$$

$$\begin{pmatrix} 0 \\ -M_L \dot{n}(t) \\ M_L \dot{p}(t) \\ 0 \\ 0 \\ 0 \end{pmatrix} + A_{FEM} \begin{pmatrix} \psi(t) \\ n(t) \\ p(t) \\ g_\psi(t) \\ j_n(t) \\ j_p(t) \end{pmatrix} + \mathcal{F}(n^h, p^h, g_\psi^h) - b(A_S^T e(t)) = 0.$$

## Outline

Motivation

PDAE-model

Finite Element Method

**Simulation results**

Construction of the reduced model

Location dependence of reduced model

Residual based parameter sampling

PABTEC and POD, joint work with A. Steinbrecher & Tatjana Stykel

## Basic test circuit, simulation results

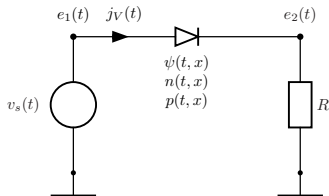

input voltage:  $v_s(t) = 5[V] \cdot \sin(2\pi f \cdot t)$   
 similar results obtained by MECS [Selva Soto]

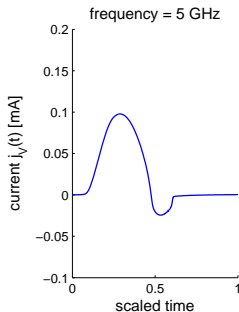
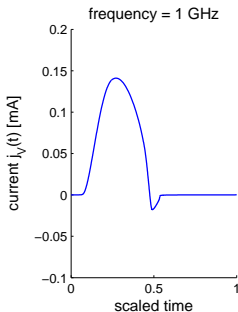
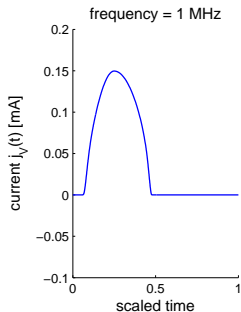

## Outline

Motivation

PDAE-model

Finite Element Method

Simulation results

**Construction of the reduced model**

Location dependence of reduced model

Residual based parameter sampling

PABTEC and POD, joint work with A. Steinbrecher & Tatjana Stykel

## Snapshot-POD (Proper Orthogonal Decomposition) [L. Sirovich '87]

Full simulation yields snapshots (here:  $y = \psi, n, p, \dots$ )

$$\{y(t_i, \cdot)\}_{i=1, \dots, m} \subset \text{span}\{\varphi_j\}_{j=1, \dots, N}, \quad \text{with} \quad y(t_i, x) = \sum_{j=1}^N \tilde{y}_j(t_i) \varphi_j(x).$$

Gather coefficients in matrix

$$Y := (\vec{y}(t_1), \dots, \vec{y}(t_m)) \in \mathbb{R}^{N \times m}.$$

POD in Hilbert space  $X$  as eigenvalue problem:

$$Kv^k = \sigma_k^2 v^k, \quad \text{with} \quad K_{ij} := \langle y(t_i, \cdot), y(t_j, \cdot) \rangle_X.$$

Note that  $K = Y^T M Y$  with  $M_{ij} = \langle \varphi_i, \varphi_j \rangle_X$ . Write POD in terms of SVD:

$$\tilde{U} \Sigma \tilde{V}^T = L^T Y, \quad \text{with} \quad LL^T := M.$$

Then, the  $s$ -dimensional POD basis is

$$\left\{ u^i := \sum_{j=1}^N \tilde{u}_j^i \varphi_j(\cdot) \right\}_{i=1, \dots, s}, \quad U := (\tilde{u}^1, \dots, \tilde{u}^s) := L^{-T} \tilde{U}_{(:, 1:s)}.$$

## Model Order Reduction

- ▶ Simulate the complete network at one or more reference parameters.
- ▶ Take snapshots of the state of each semiconductor at time points  $t_i$ .
- ▶ Perform POD **component wise** on  $\psi$ ,  $n$ ,  $p$ ,  $g_\psi$ ,  $J_n$  and  $J_p$ .
- ▶ Use the POD basis functions as (non local) Galerkin ansatz functions:

$$\psi^{POD}(t, x) = \sum_{i=1}^s \gamma_{\psi,i}(t) u_{\psi}^i(x)$$

## Reduced model

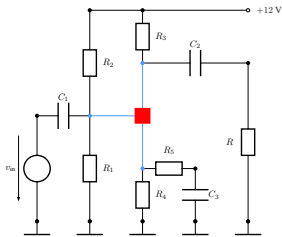

$$\begin{aligned}
 A_C \frac{dq_C}{dt} (A_C^T e(t), t) + A_{Rg} (A_R^T e(t), t) \\
 + A_L j_L(t) + A_V j_V(t) + A_S j_S(t) = -A_I i_S(t), \\
 \frac{d\phi_L}{dt} (j_L(t), t) - A_L^T e(t) = 0, \\
 A_V^T e(t) = v_S(t),
 \end{aligned}$$

$$j_S(t) - C_1 U_{J_n} \gamma_{J_n}(t) - C_2 U_{J_p} \gamma_{J_p}(t) - C_3 U_{g_\psi} \dot{\gamma}_{g_\psi}(t) = 0,$$

$$\begin{pmatrix} 0 \\ -\dot{\gamma}_n(t) \\ \dot{\gamma}_p(t) \\ 0 \\ 0 \\ 0 \end{pmatrix} + A_{POD} \begin{pmatrix} \gamma_\psi(t) \\ \gamma_n(t) \\ \gamma_p(t) \\ \gamma_{g_\psi}(t) \\ \gamma_{J_n}(t) \\ \gamma_{J_p}(t) \end{pmatrix} + U^T \mathcal{F}(n^{POD}, p^{POD}, g_\psi^{POD}) - U^T b(A_S^T e(t)) = 0.$$

# Computational complexity

Computational complexity of reduced model still depends on  $n_{FEM}$ :

$$U^T \mathcal{F}(n^{POD}, p^{POD}, g_{\psi}^{POD}) = \underbrace{U^T}_{n_{POD} \times n_{FEM}} \underbrace{F}_{n_{FEM}} \left( \underbrace{U_n}_{n_{FEM} \times n_{POD}}, \gamma_n, U_p \gamma_p, U_{g_{\psi}} \gamma_{g_{\psi}} \right).$$

With matrix-matrix multiplications in Jacobian computation:

$$\underbrace{U^T}_{n_{POD} \times n_{FEM}, \text{ block-dense}} \underbrace{F'(\dots)}_{n_{FEM} \times n_{FEM}, \text{ sparse}} \underbrace{U}_{n_{FEM} \times n_{POD}, \text{ block-dense}}.$$



## Discrete Empirical Interpolation Md. (DEIM) [S. Chaturantabut, D. Sorensen '09]

### DEIM

- ▶ Do POD on snapshots  $\{F(n(t_i), p(t_i), g_{\psi}(t_i))\}$ , obtain basis  $W \in \mathbb{R}^{n_{FEM} \times n_{DEIM}}$  (block diagonal matrix).

- ▶ Ansatz

$$F(U_n \gamma_n(t), U_p \gamma_p(t), U_{g_{\psi}} \gamma_{g_{\psi}}(t)) \approx Wc(t)$$

is overdetermined.

- ▶ Select  $n_{DEIM}$  “useful” rows:

$$P^T F(\dots) \approx P^T Wc(t).$$

- ▶ If  $P^T W$  is regular:

$$F(\dots) \approx Wc(t) = W(P^T W)^{-1} P^T F(\dots)$$

The regularity of  $P^T W$  can be guaranteed, see [CS09].  
 Again we apply the method **component-wise**.

# Discrete Empirical Interpolation Md. (DEIM) [S. Chaturantabut, D. Sorensen '09]

Reduced model

$$U^T F(U_n \gamma_n, U_p \gamma_p, U_{g_\psi} \gamma_{g_\psi})$$

with DEIM:

$$\underbrace{(U^T W (P^T W)^{-1})}_{n_{POD} \times n_{DEIM}, \text{ block-dense}} \underbrace{P^T F(U_n \gamma_n, U_p \gamma_p, U_{g_\psi} \gamma_{g_\psi})}_{\substack{n_{DEIM} \\ n_{FEM}}}$$

Results for 1D-diode:

	$n_{FEM}$	FEM	$n_{POD}$	ROM	$n_{DEIM}$	ROM + DEIM
	3003	3.15 sec.	220	3.52 sec.	187	1.93 sec.
	15009	23.5 sec.	229	19.9 sec.	198	4.04 sec.
	48015	82.3 sec.	229	74.2 sec.	199	9.87 sec.
order		$\approx n_{FEM}^{1.18}$		$\approx n_{FEM}^{1.10}$		$\approx n_{FEM}^{0.578}$

# Discrete Empirical Interpolation Md. (DEIM) [S. Chaturantabut, D. Sorensen '09]

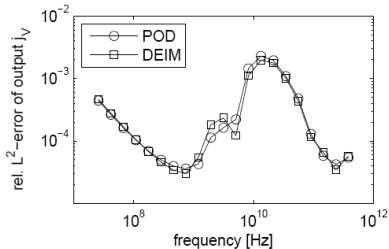
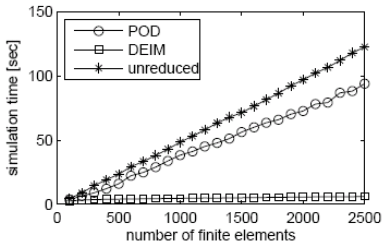

# Outline

Motivation

PDAE-model

Finite Element Method

Simulation results

Construction of the reduced model

**Location dependence of reduced model**

Residual based parameter sampling

PABTEC and POD, joint work with A. Steinbrecher & Tatjana Stykel

## Reduced model depends on position of diode in network

Bridge rectifier with 4 diodes:

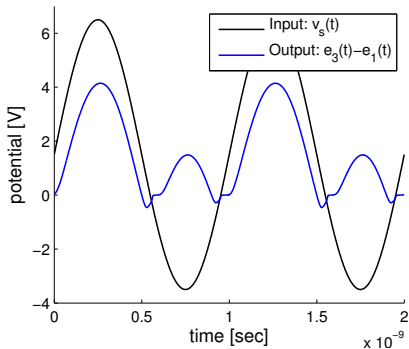
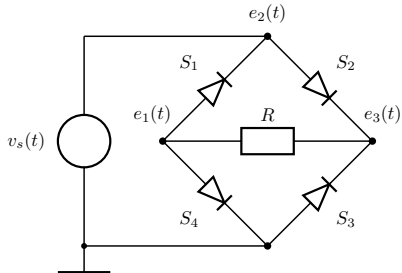

## Reduced model depends on position of diode in network

The distance between the spaces  $U^1$  and  $U^2$  which are spanned, e.g., by the POD-functions  $U_{\psi}^1$  of the diode  $S_1$  and  $U_{\psi}^2$  of the diode  $S_2$  respectively, is measured by

$$d(U^1, U^2) := \max_{\substack{u \in U^1 \\ \|u\|_2=1}} \min_{\substack{v \in U^2 \\ \|v\|_2=1}} \|u - v\|_2 = \sqrt{2 - 2\sqrt{\lambda}},$$

where  $\lambda$  is the smallest eigenvalue of the positive definite matrix  $SS^T$  with  $S_{ij} = \langle u_{\psi,i}^1, u_{\psi,j}^2 \rangle_2$ .

$\Delta$	$d(U^1, U^2)$	$d(U^1, U^3)$
$10^{-4}$	0.61288	$5.373 \cdot 10^{-8}$
$10^{-5}$	0.50766	$4.712 \cdot 10^{-8}$
$10^{-6}$	0.45492	$2.767 \cdot 10^{-7}$
$10^{-7}$	0.54834	$1.211 \cdot 10^{-6}$

Table: Distances between reduced models in the rectifier network.

# Outline

Motivation

PDAE-model

Finite Element Method

Simulation results

Construction of the reduced model

Location dependence of reduced model

**Residual based parameter sampling**

PABTEC and POD, joint work with A. Steinbrecher & Tatjana Stykel

## Problem setting

### MOR test problem

Basic circuit with **frequency  $f$**  of the voltage source  $v_s(t) = 5[V] \cdot \sin(2\pi f \cdot t)$   
 as **model parameter**.

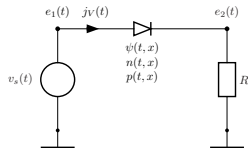

### Lack of information

Select number of snapshots so that  $\Delta(s) = \sqrt{\frac{\sum_{i=s+1}^m \sigma_i^2}{\sum_{i=1}^m \sigma_i^2}} \approx \text{tol}$ .



## Reduced model at a fixed frequency

First test: Compare reduced and unreduced system at a fixed frequency.

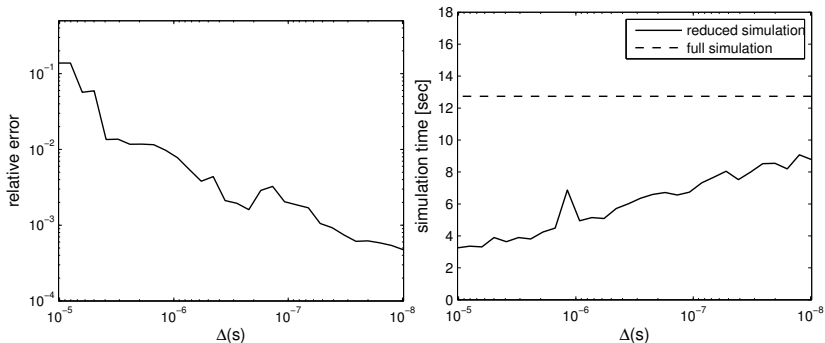

## Reduced model over parameter space

Construction of reduced model requires snapshots from full simulations at reference parameters.

Is the model valid over a large parameter space?

reference parameter:  $P_1 := \{f_1\} := \{10^{10}[\text{Hz}]\}$   
 parameter space  $\mathcal{P} = [10^8, 10^{12}]$

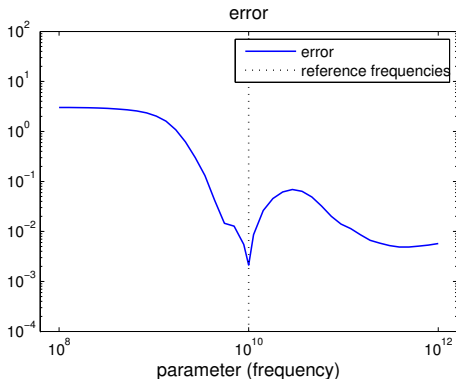

## Reduced model over parameter space - sampling

### Goal

Find new sampling parameter  $f_{k+1}$  (reference frequency) without simulating the full, unreduced system. Set  $P_{k+1} := P_k \cup \{f_{k+1}\}$ .

- ▶ We do not consider the PDE discretization error.
- ▶ Rigorous upper bound for the error not available

$$\|\mathcal{E}(f; P_k)\| = \|y^h(f) - y^{POD}(f; P_k)\| \leq ?(s)$$

where  $y^h := (\psi^h, n^h, p^h, g_\psi^h, J_n^h, J_p^h)^\top$ ,  $y^{POD} := (\psi^{POD}, n^{POD}, \dots)^\top$ .

- ▶ Rigorous RB methods, Greedy algorithm [see e.g. A. Patera, G. Rozza '07]: a-posteriori error estimates required.
- ▶ Linear ODEs [see e.g. B. Haasdonk, M. Ohlberger '09]: build difference between residual and unreduced equation to derive an ODE for the error.

## Residual based sampling

Define residual  $\mathcal{R}(z^{POD}(f; P_k))$ : insert  $z^{POD}(f; P_k)$  into unreduced equation,

$$\mathcal{R} := \begin{pmatrix} 0 \\ -M_L \dot{n}^{POD}(t) \\ M_L \dot{p}^{POD}(t) \\ 0 \\ 0 \\ 0 \end{pmatrix} + A_{FEM} \begin{pmatrix} \psi^{POD}(t) \\ n^{POD}(t) \\ p^{POD}(t) \\ g_{\psi}^{POD}(t) \\ J_n^{POD}(t) \\ J_p^{POD}(t) \end{pmatrix} + \mathcal{F}(n^{POD}, p^{POD}, g_{\psi}^{POD}) - b(e^{POD}(t)).$$

**Residual admits different scales.**

Scale with block diagonal matrix-valued function

$$D(f) := \text{diag}(d_{\psi}(f)I, d_n(f)I, d_p(f)I, d_{g_{\psi}}(f)I, d_{J_n}(f)I, d_{J_p}(f)I)$$

and choose  $d_{\psi}(f)$  according to

$$d_{\psi}(f_j) \cdot \|\mathcal{R}_{\psi}(y^{POD}(f_j; P_k))\| = \frac{\|\psi^h(f_j) - \psi^{POD}(f_j; P_k)\|}{\|\psi^h(f_j)\|}, \quad \forall f_j \in P_k.$$

## Residual based sampling

### Algorithm: sampling

1. Select  $f_1 \in \mathcal{P}$ ,  $P_{test} \subset \mathcal{P}$ ,  $tol > 0$ , and set  $k := 1$ ,  $P_1 := \{f_1\}$ .
2. Simulate the unreduced model at  $f_1$  and calculate the reduced model with POD basis functions  $U_1$ .
3. Calculate weight functions  $d_{(\cdot)}(f) > 0$  for all  $f \in P_k$ .
4. Calculate the scaled residual  $\|D(f)\mathcal{R}(z^{POD}(f, P_k))\|$  for all  $f \in P_{test}$ .
5. Check termination conditions, e.g.
  - ▶  $\max_{f \in P_{test}} \|D(f)\mathcal{R}(z^{POD}(f, P_k))\| < tol$ ,
  - ▶ no progress in weighted residual.
6. Calculate  $f_{k+1} := \arg \max_{f \in P_{test}} \|D(f)\mathcal{R}(z^{POD}(f, P_k))\|$ .
7. Simulate the unreduced model at  $f_{k+1}$  and create a new reduced model with POD basis  $U_{k+1}$  using also the already available information at  $f_1, \dots, f_k$ .
8. Set  $P_{k+1} := P_k \cup \{f_{k+1}\}$ ,  $k := k + 1$  and goto 3.

## Numerical example - sampling step 1

Let  $f_1 := 10^{10}[\text{Hz}]$ ,  $P_1 := \{10^{10}[\text{Hz}]\}$ ,  $\mathcal{P} = [10^8, 10^{12}]$ .

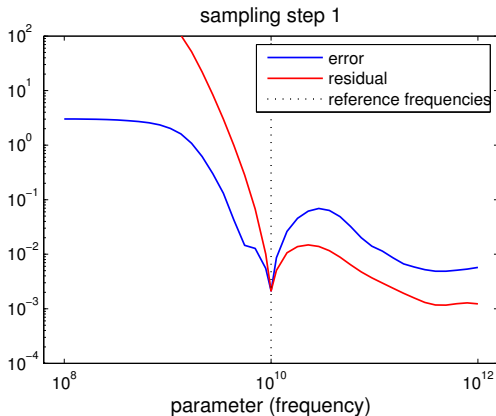

$$f_2 = \arg \max_{f \in P_{\text{test}}} \|D(f)\mathcal{R}(z^{\text{POD}}(f, P_1))\| = 10^8[\text{Hz}]$$

$$P_2 = \{10^8[\text{Hz}], 10^{10}[\text{Hz}]\}$$

## Numerical example - sampling step 2

$$P_2 = \{10^8[\text{Hz}], 10^{10}[\text{Hz}]\}$$

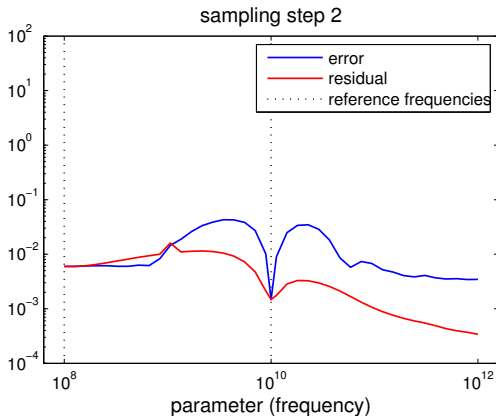

$$f_3 = \arg \max_{f \in P_{\text{test}}} \|D(f)\mathcal{R}(z^{\text{POD}}(f, P_2))\| = 1.0608 \cdot 10^9[\text{Hz}]$$

$$P_3 = \{10^8[\text{Hz}], 1.0608 \cdot 10^9[\text{Hz}], 10^{10}[\text{Hz}]\}$$

## Numerical example - sampling step 3

$$P_3 = \{10^8[\text{Hz}], 1.0608 \cdot 10^9[\text{Hz}], 10^{10}[\text{Hz}]\}$$

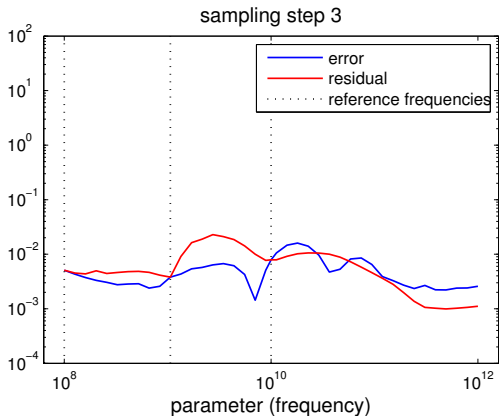

Terminate with “no progress in residual”.



## Outline

Motivation

PDAE-model

Finite Element Method

Simulation results

Construction of the reduced model

Location dependence of reduced model

Residual based parameter sampling

PABTEC and POD, joint work with A. Steinbrecher & Tatjana Stykel

# Combination of PABTEC (Reis & Stykel 2010) and POD; joint work with [A. Steinbrecher, T. Stykel]

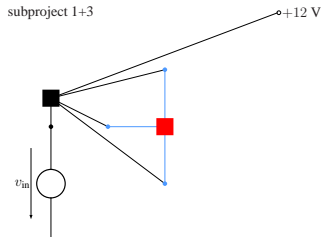
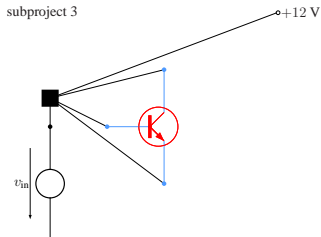
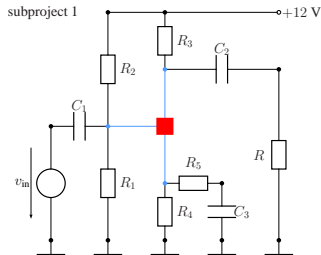
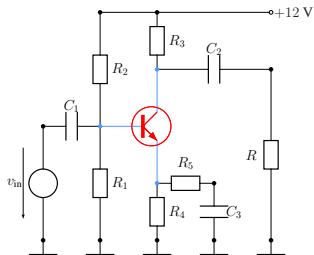

## Combination of PABTEC (Reis & Stykel '10) and POD

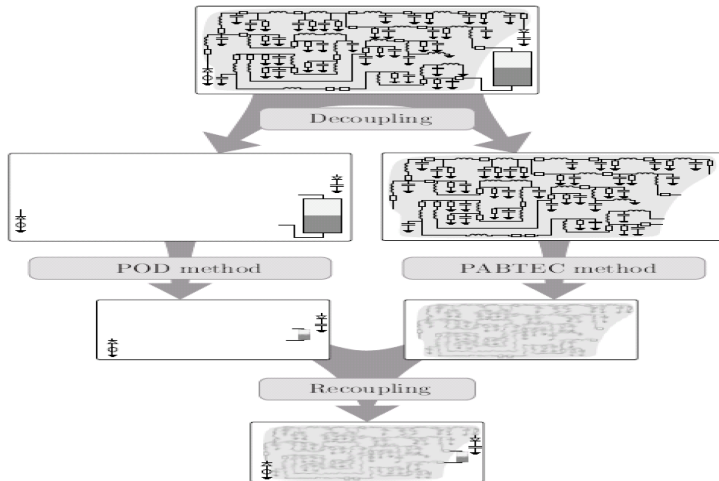

## Substitution of nonlinear components for PABTEC and recoupling

A. Steinbrecher, T. Stykel (Int. J. Circuits Theory Appl., 2012):

Nonlinear inductor  $\rightarrow$  current source

Nonlinear capacitor  $\rightarrow$  voltage source

Nonlinear resistor  $\rightarrow$  linear circuit with 2 serial resistors and one voltage source parallel to one of the resistors

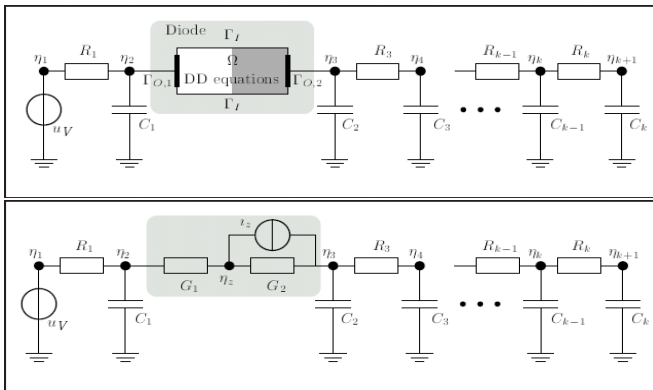

## Combination of PABTEC and POD; Int. J. Numer. Model. 2012

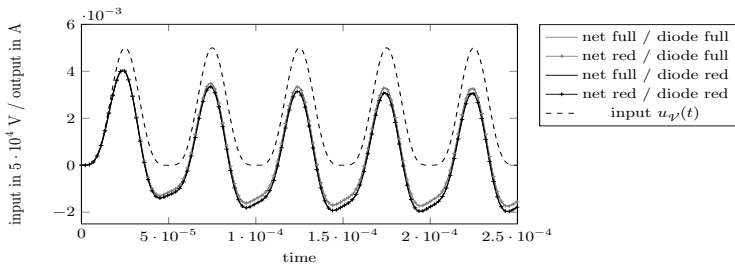

network (MNA equations)		diode (DD equations)		coupled system dim.	simul. time	Jacobian evaluations	absolute error $\ y - \hat{y}\ _{L_2}$	relative error $\frac{\ y - \hat{y}\ _{L_2}}{\ y\ _{L_2}}$
type	dim.	type	dim.					
unreduced	1503	unreduced	6006	7510	23.37s	20		
reduced	24	unreduced	6006	6031	16.90s	17	$2.165 \cdot 10^{-8}$	$7.335 \cdot 10^{-4}$
unreduced	1503	reduced	105	1609	1.51s	16	$2.952 \cdot 10^{-6}$	$1.000 \cdot 10^{-1}$
reduced	24	reduced	105	130	1.19s	11	$2.954 \cdot 10^{-6}$	$1.000 \cdot 10^{-1}$

## Some literature

- M.H., M. Kunkel, U. Matthes, M. Vierling: Model order reduction of integrated circuits in electrical networks. System Reduction for Nanoscale IC Design Hamburger, Peter Benner (Ed), Mathematics in Industry 20, 2014.
- A. Steinbrecher, T. Stykel: Model order reduction of nonlinear circuit equations. Internat. J. Circuit Theory Appl., 41, 2013, pp.1226-1247.
- M.H., M. Kunkel, A. Steinbrecher, T. Stykel: Model order reduction of coupled circuit-device systems. Int. J. Numer. Model. 25:362-377 (2012).
- M.H., M. Kunkel: Residual Based Sampling in POD Model Order Reduction of Drift-Diffusion Equations in Parametrized Electrical Networks. ZAMM 92:91-104 (2012).
- M.H., U. Matthes: Model order reduction for networks of ODE and PDE systems. D. Hömberg and F. Tröltzsch (Eds.): CSMO 2011, IFIP AICT 391, pp. 92-101, 2013.
- M.H., M. Kunkel, M. Vierling: POD Model Order Reduction of Drift-Diffusion Equations in Electrical Networks. Lecture Notes in Electrical Engineering, Vol. 74, (2011).
- M.H., M. Kunkel, U. Matthes: POD Model Order Reduction of electrical networks with semiconductors modeled by the transient Drift-Diffusion equations. Proceedings of the ECMI Wuppertal 2010 (2010).
- M.H., M. Kunkel: Discrete empirical interpolation in POD Model Order Reduction of Drift-Diffusion Equations in Electrical Networks. SCEE Proceedings 2010, Toulouse (2010).

## Next steps

- ▶ Include QDD models.
- ▶ Include EM effects.
- ▶ Apply approach to other equation networks containing simple and complex components.

Thank you for attending!



The work reported in this talk is supported by the German Federal Ministry of Education and Research (BMBF), grants 03HIPAE5 & 03MS613D.



## Next steps

- ▶ Include QDD models.
- ▶ Include EM effects.
- ▶ Apply approach to other equation networks containing simple and complex components.

Thank you for attending!



The work reported in this talk is supported by the German Federal Ministry of Education and Research (BMBF), grants 03HIPAE5 & 03MS613D.

